

INSTALLATION MANUAL
INSTALLATIEHANDLEIDING
MANUEL D'INSTALLATION
INSTALLATIONSANLEITUNG

GB

NL

F

D

Appendix

Phoenix Multi

12/2000/100

12/3000/120

24/2000/60

24/3000/70

48/3000/35

Phoenix MultiPlus

12/2000/100

12/3000/120

24/2000/60

24/3000/70

48/3000/35

Phoenix Inverter

12/3000

24/3000

48/3000

VICTRON ENERGY AT ANY TIME

 victron energy

This publication or parts thereof, may not be reproduced in any form, by any method, for any purpose.

For conditions of use and permission to use this manual for publication in other than the English language, contact Victron Energy B.V.

VICTRON ENERGY B.V. MAKES NO WARRANTY, EITHER EXPRESSED OR IMPLIED, INCLUDING BUT NOT LIMITED TO ANY IMPLIED WARRANTIES OF MERCHANTABILITY OR FITNESS FOR A PARTICULAR PURPOSE, REGARDING THESE VICTRON ENERGY PRODUCTS AND MAKES SUCH VICTRON ENERGY PRODUCTS AVAILABLE SOLELY ON AN "AS IS" BASIS.

IN NO EVENT SHALL VICTRON ENERGY B.V. BE LIABLE TO ANYONE FOR SPECIAL, COLLATERAL, INCIDENTAL, OR CONSEQUENTIAL DAMAGES IN CONNECTION WITH OR ARISING OUT OF PURCHASE OR USE OF THESE VICTRON ENERGY PRODUCTS. THE SOLE AND EXCLUSIVE LIABILITY TO VICTRON ENERGY B.V., REGARDLESS OF THE FORM OF ACTION, SHALL NOT EXCEED THE PURCHASE PRICE OF THE VICTRON ENERGY PRODUCTS DESCRIBED HERE IN.

Victron Energy B.V. reserves the right to revise and improve its products as it sees fit. This publication describes the state of this product at the time of its publication and may not reflect the product at all times in the future.

1. INSTALLATION



This product should be installed by a qualified electrician

GB

NL

F

D

Appendix

1.1 Box Contents

- Phoenix Multi, MultiPlus, or Inverter
- User manual.
- Installation manual.
- Bag containing connection items, i.e.:
 - Temperature sensor.
 - Fuse (Mega fuse).
 - Four M8 nuts.
 - Four M8 washers.
 - Four M8 spring washers.
 - Charging current warning sticker.

1.2 Location

The product must be installed in a dry and well-ventilated area, as close as possible to the batteries. There should be a clear space of at least 10 cm around the appliance for cooling.



Excessively high ambient temperature will result in the following:

- Reduced service life.
 - Reduced charging current.
 - Reduced peak capacity, or shutdown of the inverter.
- Never position the appliance directly above the batteries.

The product is suitable for wall mounting. The back of the enclosure has holes for wall mounting purposes, see Appendix B.

The appliance can be mounted horizontally as well as vertically; vertical mounting is preferable. The vertical position offers optimum cooling.



The interior of the product must remain accessible after installation.

Ensure that the AC and DC input cables are fitted with fuses and circuit breakers. Try and keep the distance between the product and the battery to a minimum in order to minimize cable voltage losses.



For safety purposes, this product should be installed in a heat-resistant environment. You should prevent the presence of e.g. chemicals, synthetic components, curtains or other textiles, etc., in the immediate vicinity.

1.3 Requirements

- Philips screwdriver (PH2) for removing the front.
- Flat screwdriver (0.6x3.5) for connecting the AC leads.
- Insulated box spanner (13 mm) for securing the terminal nuts and the fuse.
- Two battery cable including battery terminals and cable ends.
- Three-wire cable.

1.4 Connection of Battery cables

In order to fully utilize the full capacity of the product, batteries with sufficient capacity and battery cables with sufficient cross section should be used. See table.

	12/2000/100	12/3000/120	24/2000/60	24/3000/70	48/3000/35
Recommended battery capacity (Ah)	200–700	400–1200	100–400	200–700	100–400
Recommended cross section (mm ²)					
0 – 5 m	70	90	40	50	35
5 – 10 m	100	120	70	90	70

Remark: Internal resistance is the important factor when working with low capacity batteries. Please consult your supplier or the relevant sections of our book “electricity on board”, downloadable from our website.

Procedure

Proceed as follows to connect the battery cables:



Use an insulated box spanner in order to avoid shorting the battery. Avoid shorting the battery cables.

- Undo the four screws at the front of the enclosure and remove the front panel.
- Connect the battery cables: the + (red) on the right and the - (black) on the left, see Appendix A.
- Reverse polarity connection (+ to – and – to +) will cause the “reversed polarity” LED next to the terminal nuts to light up.
- Disconnect the cables and reconnect them correctly if the “reversed polarity” LED is illuminated.
- Tighten the connections after positioning the fastening items supplied with the product.
- Position the Mega fuse from the connection bag in position F4 and secure it, using the fastening items supplied with the product.
- Secure the nuts tightly in order to reduce the contact resistance as much as possible.

1.5 Connection of the AC cabling

This is a Safety Class I product (supplied with a protective grounding terminal). **Uninterruptible protective grounding must be provided at the AC input and/or output terminals and/or chassis grounding point located externally on the product. See the following instructions:**

a) The Phoenix Inverter has a free floating AC output. The grounding point located externally on the product **must** be used to ground the chassis. The neutral output wire must be connected to ground to ensure proper functioning of a GFCI (Ground Fault Circuit Interrupter).



b) Phoenix Multi / MultiPlus: **the output neutral wire will automatically be bonded to the chassis** (with the output ground relay, see appendix) **when no external AC source is available** (backfeed / safety relay open and product running in inverter mode, see appendix). When an external AC source is provided, the ground relay opens before closure of the backfeed / safety relay. Once closed, the backfeed / safety relay ensures that the neutral to ground bond is provided by the external AC source. This is to ensure proper functioning of a GFCI to be installed in the AC output of the Multi/MultiPlus.

- In a fixed (for example terrestrial) installation an uninterrupted chassis ground may be provided by the AC input ground wire.
- In case of a mobile installation (connection to input AC with a shore power cord), the ground connection is lost when the shore power cord is unplugged. In this case the chassis of the product or the on - board section of the input ground wire must be connected to the frame (of the vehicle) or the ground plate or hull (of a boat).
- Marine applications: due to the potential for galvanic corrosion it is in general not acceptable to connect the shore side ground to the ground plate or hull of the boat. The proper and safe solution is to install an isolation transformer.

The terminal block can be found on the printed circuit board, see Appendix A. The shore or mains cable must be connected to the Multi with the aid of a three-wire cable. Use a three-wire cable with a flexible core and a cross section of 2.5 or 4 mm²

Procedure

Proceed as follows to connect the AC cables:

- The AC output cable can be connected directly to the terminal block containing the words "AC-out". The terminal points are indicated clearly. From left to right: "PE" (earth), "N" (neutral) and "L" (phase).
- The AC input cable can be connected to the terminal block containing the words "AC-in". The terminal points are indicated clearly. "PE" (earth) "N" (neutral) and "L" (phase).

1.6 Optional Connections

A number of optional connections are possible:

1.6.1 Second Battery

The Phoenix Multi/ MultiPlus has a connection for charging a starter battery. For connection see Appendix A.

1.6.2 Voltage Sense (Multi/ MultiPlus)

Two sense wires may be connected to compensate possible battery cable losses during charging. Use wires of at least 0.75mm^2 . For connection see Appendix A.

1.6.3 Temperature Sensor (Multi/ MultiPlus)

The temperature sensor supplied with the product may be used for temperature-compensated charging (see Appendix A). The sensor is insulated and must be mounted on the batteries minus pole.

1.6.4 Remote Control

The product can be operated remotely in two ways.

- Use of only an external switch.
- With a Phoenix Multi Control panel.

For connection of the switch see Appendix A.

Observe the following when using only an external switch:

- Only functions if the switch on the product is switched to the "on" position.
- Not to be connected if a remote control panel is connected.

For connection of the remote control panel, see Appendix A.

Observe the following when using a remote control panel:

- Only functions if the switch on the product is switched to the "on" position.

1.6.5 External Relay (Multi/ MultiPlus)

The maximum current that can be switched through from the AC input to the AC output is 16 A (optional: 30 A). At more than 16 A an external contactor is needed: please consult your supplier.

1.6.6 Parallel Connection

The product can be connected in parallel using several identical models, see Appendix G. The batteries must be connected in accordance with Appendix E or F. This requires interconnecting the products with the aid of a special cable to be supplied by Victron Energy, in conjunction with a connection diagram.

Parallel connection requires compliance with the following conditions:

- No more than five units should be connected in parallel.
- Only identical models should be connected in parallel (**exception:** for MultiPlus functionality only the Master needs to be a MultiPlus).
- Ensure sufficient battery capacity is available.
- The prescribed cable cross sections (between battery and distribution point) must be multiplied with the number of appliances to be connected in parallel.
- Position the products close to each other but ensure there is adequate clearance for ventilation, min. 10 cm.
- The temperature sensor, voltage sensor and remote control must be connected to the master.
- The cables for each appliance must be equal in length (AC and DC).

1.6.7 3-phase operation

The Phoenix Multi/MultiPlus can also be used in a 3-phase system, see Appendix O. The batteries must be connected in accordance with Appendix E or F. The following conditions should be complied with in the case of 3-phase operation:

- Only identical models should be used.
- Ensure sufficient battery capacity is available.
- Position the products close to each other but ensure there is adequate clearance for ventilation (min. 10 cm)
- The temperature sensor and voltage sensor should preferably be connected to all three products.
- Only a single remote control can be connected, using splitters.

2. SETTINGS



- Settings may only be changed by a qualified engineer
- Carefully read the instructions before changes are made.
- When setting the charger, all connections to the battery must be disconnected from the Phoenix Multi or MultiPlus.
- Do not use non-rechargeable batteries.
- The Phoenix Multi/ MultiPlus default settings are for charging Sonnenschein Dryfit A200 gel batteries. For the recommended battery voltage see section 2.4.
- Batteries should be placed in a dry and well-ventilated area during charging.

2.1 Settings – General

2.1.1 Push buttons and dipswitches

A selected number of settings may be changed with the aid of pushbuttons and dip switches (see Appendix A).

Dipswitches are used to activate set-up, and to determine the setting to be changed. The value of this setting can be changed with the aid of the pushbuttons.

The value specified is shown on the LEDs. Sections 2.3 describes how the LEDs can be read.

2.1.2 VEConfigure software

All settings can be changed with VEConfigure.

VEConfigure can be downloaded from www.victronenergy.com

2.2 Default Settings

System frequency	50 Hz
Inverter Voltage	230 Vac
Charger on/ off	on
Charger characteristic	Adaptive with BatterySafe mode
Charging Current	75% of maximum charging current
Battery Type Presets	type 1 (Exide Gel battery)
Absorption Voltage	14.4/ 28.8/ 57.6 Vdc
Absorption Time/ Maximum Absorption Time	4 hours
Float Voltage	13.8/ 27.6/ 55.2 Vdc
Repeated Absorption Time	1 hour
Repeated Absorption Interval	7 days
Bulk Protection	on
AC Waveform Check	on
Generator/ Shore Current	16 A (optional: 30 A)
PowerAssist (MultiPlus only)	on
3-phase Setting	off
Master/ slave	slave

(To restore the default settings, both pushbuttons should be held down for 3 seconds while set-up is activated)

2.3 Changing settings with the push buttons and dipswitches

2.3.1 Activate Set-up

DS-8 <input checked="" type="checkbox"/> on DS-7 <input type="checkbox"/> DS-6 <input type="checkbox"/> DS-5 <input type="checkbox"/> DS-4 <input type="checkbox"/> DS-3 <input type="checkbox"/> DS-2 <input type="checkbox"/> DS-1 <input type="checkbox"/>	DS-8 <input type="checkbox"/> DS-7 <input type="checkbox"/> DS-6 <input type="checkbox"/> DS-5 <input type="checkbox"/> DS-4 <input type="checkbox"/> DS-3 <input type="checkbox"/> DS-2 <input type="checkbox"/> DS-1 <input type="checkbox"/>	DS-8 <input type="checkbox"/> DS-7 <input type="checkbox"/> DS-6 <input type="checkbox"/> DS-5 <input type="checkbox"/> DS-4 <input type="checkbox"/> DS-3 <input type="checkbox"/> DS-2 <input type="checkbox"/> DS-1 <input type="checkbox"/>	DS-8 <input checked="" type="checkbox"/> off DS-7 <input type="checkbox"/> DS-6 <input type="checkbox"/> DS-5 <input type="checkbox"/> DS-4 <input type="checkbox"/> DS-3 <input type="checkbox"/> DS-2 <input type="checkbox"/> DS-1 <input type="checkbox"/>
Activate set-up with DS8 switched to On	Select a setting using DS3 - DS7 and set the new value using the pushbuttons.	Store the settings by changing the position of one of the switches DS3-DS7	Close set-up by switching DS8 to Off

DS-1 and DS-2 are not used and must be switched to Off.

NOTE: The new value is stored by changing the position of one of the switches DS3-DS7. The new value is NOT stored if set-up is closed without changing the position of one of the switches DS3-DS7. This offers an escape route if the change is not to be implemented.

2.3.2 Reading LEDs – setting values (Multi/ MultiPlus)

The value of a setting can be determined on the basis of the following formula:

$$Value\ set = setting\ number * scale + offset$$

The 'offset' and the 'scale' are specified for each setting.

The setting number is indicated as follows via the LEDs:

The LEDs are divided into 2 columns of 4 LEDs each.

Each column indicates the numbers 0 - 9.

These columns together indicate 2-digit numbers.

The left column indicates the left-hand digit. The right-hand column shows the right-hand digit.

The digit in a column can be determined by adding the separate 'LED values'.

A flashing LED counts as 1 and an illuminated LED as 2.

A special case is 4 flashing LEDs. This signifies a 9.

Symbol	Meaning	LED value
○	LED off	0
☀	LED flashes	1
●	LED lit up	2
☀ ☀ ☀ ☀	All LEDs in a column are flashing	9

Examples of setting numbers:

<table style="border-collapse: collapse;"> <tr><td>○</td><td>0</td><td>○</td><td>0</td></tr> <tr><td>○</td><td>0</td><td>●</td><td>2</td></tr> <tr><td>○</td><td>0</td><td>●</td><td>2</td></tr> <tr><td>○</td><td>0</td><td>●</td><td>2</td></tr> <tr><td colspan="2" style="border-top: 1px solid black; border-bottom: 1px solid black;">0</td><td colspan="2" style="border-top: 1px solid black; border-bottom: 1px solid black;">6</td></tr> </table>	○	0	○	0	○	0	●	2	○	0	●	2	○	0	●	2	0		6		=6
○	0	○	0																		
○	0	●	2																		
○	0	●	2																		
○	0	●	2																		
0		6																			

<table style="border-collapse: collapse;"> <tr><td>○</td><td>0</td><td>☀</td><td>1</td></tr> <tr><td>○</td><td>0</td><td>●</td><td>2</td></tr> <tr><td>●</td><td>2</td><td>●</td><td>2</td></tr> <tr><td>●</td><td>2</td><td>●</td><td>2</td></tr> <tr><td colspan="2" style="border-top: 1px solid black; border-bottom: 1px solid black;">4</td><td colspan="2" style="border-top: 1px solid black; border-bottom: 1px solid black;">7</td></tr> </table>	○	0	☀	1	○	0	●	2	●	2	●	2	●	2	●	2	4		7		=47
○	0	☀	1																		
○	0	●	2																		
●	2	●	2																		
●	2	●	2																		
4		7																			

<table style="border-collapse: collapse;"> <tr><td>○</td><td>0</td><td>☀</td></tr> <tr><td>○</td><td>0</td><td>☀</td></tr> <tr><td>☀</td><td>1</td><td>☀</td></tr> <tr><td>●</td><td>2</td><td>☀</td></tr> <tr><td colspan="2" style="border-top: 1px solid black; border-bottom: 1px solid black;">3</td><td style="border-top: 1px solid black; border-bottom: 1px solid black;">9</td></tr> </table>	○	0	☀	○	0	☀	☀	1	☀	●	2	☀	3		9	=39
○	0	☀														
○	0	☀														
☀	1	☀														
●	2	☀														
3		9														

The increments can be smaller than the reading (scale value). In that case, a pushbutton should be pressed repeatedly before the LED indication changes.

2.3.3 Reading LEDs – on-off (Multi/ MultiPlus)

In addition to the facility of setting a value, there is an on- off facility. This allows for switching on/ off a particular setting, or for activating/ deactivating it. The left-hand column offers possibility A and the right-hand column offers possibility B in the case of a dual choice setting.

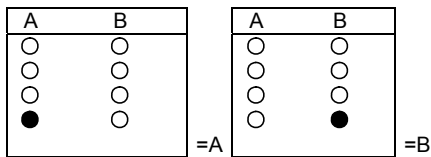

The default setting is always A.

The definitions for A and B are shown with the value to be set.

2.3.4 System Frequency (default: 50 Hz, with 45 – 65 Hz tracking range of AC input (Multi/MultiPlus only, see note below))

The product can operate at 50Hz as well as at 60Hz.

Set the DS 3-7	Specify the frequency	Example										
DS-8 <input type="text"/> DS-7 <input type="text"/> off DS-6 <input type="text"/> off DS-5 <input type="text"/> on DS-4 <input type="text"/> off DS-3 <input type="text"/> off DS-2 <input type="text"/> DS-1 <input type="text"/>	Specify the required frequency. The default setting is 50Hz. The left row of LEDs is for 50Hz. The right row of LEDs is for 60Hz. Press the buttons until the required LED indication appears.	Required: frequency is 60Hz. LED indication = <table border="1"> <thead> <tr> <th>50Hz</th> <th>60Hz</th> </tr> </thead> <tbody> <tr> <td><input type="radio"/></td> <td><input type="radio"/></td> </tr> <tr> <td><input type="radio"/></td> <td><input type="radio"/></td> </tr> <tr> <td><input type="radio"/></td> <td><input type="radio"/></td> </tr> <tr> <td><input type="radio"/></td> <td><input checked="" type="radio"/></td> </tr> </tbody> </table>	50Hz	60Hz	<input type="radio"/>	<input type="radio"/>	<input type="radio"/>	<input type="radio"/>	<input type="radio"/>	<input type="radio"/>	<input type="radio"/>	<input checked="" type="radio"/>
50Hz	60Hz											
<input type="radio"/>	<input type="radio"/>											
<input type="radio"/>	<input type="radio"/>											
<input type="radio"/>	<input type="radio"/>											
<input type="radio"/>	<input checked="" type="radio"/>											

Note:

The Phoenix inverter will operate at a fixed frequency of 50Hz or 60Hz.

The Phoenix Multi/MultiPlus will, when no AC input present, likewise operate at a fixed frequency of 50Hz or 60Hz.

When AC input is present, it will track the input frequency from 45 to 65 Hz. This to be able to connect to both 50Hz and 60Hz supply.

The tracking range can be reduced to 45 – 55 Hz or 55 – 65 Hz with VEConfigure.

2.3.5 Inverter Settings

Inverter Voltage (default: 230 V)

The inverter voltage can be set between 180Vac-245Vac.

Set the DS 3-7	Specify the voltage	Example																				
DS-8 <input type="text"/> DS-7 <input type="checkbox"/> on DS-6 <input type="checkbox"/> on DS-5 <input type="checkbox"/> off DS-4 <input type="checkbox"/> off DS-3 <input type="checkbox"/> off DS-2 <input type="text"/> DS-1 <input type="text"/>	Specify the required voltage V_q . Determine the setting number: $scale = 1V$ $offset = 180V \text{ setting}$ $number = (V_q - 180)$ Determine the LED indication. Press the pushbuttons until the required LED indication is displayed.	Required: voltage is 225V. Setting number = $225 - 180 = 45$. LED indication = <table border="1" style="margin-left: 20px;"> <tr> <td><input type="checkbox"/></td><td>0</td> <td><input type="checkbox"/></td><td>0</td> </tr> <tr> <td><input type="checkbox"/></td><td>0</td> <td><input checked="" type="checkbox"/></td><td>1</td> </tr> <tr> <td><input checked="" type="checkbox"/></td><td>2</td> <td><input checked="" type="checkbox"/></td><td>2</td> </tr> <tr> <td><input checked="" type="checkbox"/></td><td>2</td> <td><input checked="" type="checkbox"/></td><td>2</td> </tr> <tr> <td></td><td><u>4</u></td> <td></td><td><u>5</u></td> </tr> </table>	<input type="checkbox"/>	0	<input type="checkbox"/>	0	<input type="checkbox"/>	0	<input checked="" type="checkbox"/>	1	<input checked="" type="checkbox"/>	2	<input checked="" type="checkbox"/>	2	<input checked="" type="checkbox"/>	2	<input checked="" type="checkbox"/>	2		<u>4</u>		<u>5</u>
<input type="checkbox"/>	0	<input type="checkbox"/>	0																			
<input type="checkbox"/>	0	<input checked="" type="checkbox"/>	1																			
<input checked="" type="checkbox"/>	2	<input checked="" type="checkbox"/>	2																			
<input checked="" type="checkbox"/>	2	<input checked="" type="checkbox"/>	2																			
	<u>4</u>		<u>5</u>																			

Increment size is 1V.

NOTE: for setting the voltage of the Phoenix Inverter a voltage meter is to be used, because the Phoenix Inverter has only 4 LEDs.

2.3.6 Setting the Charger (Multi/ MultiPlus)

When setting the charger, all connections between the battery and the Phoenix Multi must be disconnected.

Please read our book "electricity on board"

(downloadable from our website www.victronenergy.com) for details and suggestions about charging batteries.

2.3.6.1 Charger On/ Off (default: on)

The Phoenix Multi charger can be switched off if required.

The default is on.

Set the DS 3-7	Switch the charger on or off	Example										
DS-8 <input type="checkbox"/> DS-7 <input type="checkbox"/> on DS-6 <input type="checkbox"/> off DS-5 <input type="checkbox"/> off DS-4 <input type="checkbox"/> on DS-3 <input type="checkbox"/> off DS-2 <input type="checkbox"/> DS-1 <input type="checkbox"/>	Determine whether the charger is to be switched on or off. The default is On. The left-hand LED column is for On. The right-hand LED column is for Off. Press the pushbuttons until the required LED indication is displayed.	Required: charger is off. LED indication = <table border="1" style="margin-left: 20px;"> <thead> <tr> <th>On</th> <th>Off</th> </tr> </thead> <tbody> <tr> <td><input type="checkbox"/></td> <td><input type="checkbox"/></td> </tr> <tr> <td><input type="checkbox"/></td> <td><input type="checkbox"/></td> </tr> <tr> <td><input type="checkbox"/></td> <td><input type="checkbox"/></td> </tr> <tr> <td><input type="checkbox"/></td> <td><input checked="" type="checkbox"/></td> </tr> </tbody> </table>	On	Off	<input type="checkbox"/>	<input type="checkbox"/>	<input type="checkbox"/>	<input type="checkbox"/>	<input type="checkbox"/>	<input type="checkbox"/>	<input type="checkbox"/>	<input checked="" type="checkbox"/>
On	Off											
<input type="checkbox"/>	<input type="checkbox"/>											
<input type="checkbox"/>	<input type="checkbox"/>											
<input type="checkbox"/>	<input type="checkbox"/>											
<input type="checkbox"/>	<input checked="" type="checkbox"/>											

2.3.6.2 Preprogrammed Charging Characteristics

The Phoenix Multi/ MultiPlus has 3 pre-programmed charging characteristics:

Fixed Charging Characteristic:

The absorption period is a fixed preset period. Following the absorption mode, the charger switches to float. In order to "refresh" the battery, the charger periodically switches back to absorption.

Adaptive Charging Characteristic:

The absorption period depends on the charge delivered during bulk. This is followed by float phase lasting 24 hours, after which the voltage is reduced by an additional 0.8 V, 1.6 V and 3.2 V resp. for 12 V, 24 V and 48V batteries. (reduced float). As with the Fixed-charging characteristic, the charger will periodically switch back to absorption.

Adaptive Charging Characteristic with BatterySafe mode (default setting):

If, in order to quickly charge a battery, a high charge current in combination with a high absorption voltage has been chosen, the Phoenix charger will prevent damage due to excessive gassing by automatically limiting the rate of voltage increase once the gassing voltage has been reached

Set the DS 3-7	Set the charging characteristic	Example																								
DS-8 <input type="checkbox"/> DS-7 <input type="checkbox"/> off DS-6 <input type="checkbox"/> on DS-5 <input type="checkbox"/> on DS-4 <input type="checkbox"/> on DS-3 <input type="checkbox"/> off DS-2 <input type="checkbox"/> DS-1 <input type="checkbox"/>	Determine the required charging characteristic: 1: Fixed 2: Adaptive 3: Adaptive with BatterySafe mode (default) Press the pushbuttons until the required LED indication is displayed.	Required: charging characteristic is Fixed. Setting number = 1. LED indication = <table border="1" style="margin-left: 20px;"> <tr> <td><input type="radio"/></td> <td>0</td> <td><input type="radio"/></td> <td>0</td> </tr> <tr> <td><input type="radio"/></td> <td>0</td> <td><input type="radio"/></td> <td>0</td> </tr> <tr> <td><input type="radio"/></td> <td>0</td> <td><input type="radio"/></td> <td>0</td> </tr> <tr> <td><input type="radio"/></td> <td>0</td> <td><input checked="" type="radio"/></td> <td>1</td> </tr> <tr> <td colspan="2"><hr/></td> <td colspan="2"><hr/></td> </tr> <tr> <td colspan="2">0</td> <td colspan="2">1</td> </tr> </table>	<input type="radio"/>	0	<input type="radio"/>	0	<input type="radio"/>	0	<input type="radio"/>	0	<input type="radio"/>	0	<input type="radio"/>	0	<input type="radio"/>	0	<input checked="" type="radio"/>	1	<hr/>		<hr/>		0		1	
<input type="radio"/>	0	<input type="radio"/>	0																							
<input type="radio"/>	0	<input type="radio"/>	0																							
<input type="radio"/>	0	<input type="radio"/>	0																							
<input type="radio"/>	0	<input checked="" type="radio"/>	1																							
<hr/>		<hr/>																								
0		1																								

2.3.6.3 Charge Current

The default charging current is 75% of the maximum charging current. This current will be too high for most applications. For most battery types the optimal charging current is 0.1-0.2x the battery capacity.

Set the DS 3-7	Set the charging current	Example																								
DS-8 <input type="checkbox"/> DS-7 <input type="checkbox"/> off DS-6 <input type="checkbox"/> on DS-5 <input type="checkbox"/> off DS-4 <input type="checkbox"/> off DS-3 <input type="checkbox"/> off DS-2 <input type="checkbox"/> DS-1 <input type="checkbox"/>	Determine the required charging current I_q . Determine the setting number. $Scale = 2A$ $Offset = 0A$ $Setting\ number = I_q/2$ Determine the LED indication. Press the pushbuttons until the required LED indication is displayed.	Battery capacity is 450Ah. The recommended maximum charging current is $450 \cdot 0.2 = 90A$. Setting number = $90/2 = 45$. LED indication = <table border="1" style="margin-left: 20px;"> <tr> <td><input type="radio"/></td> <td>0</td> <td><input type="radio"/></td> <td>0</td> </tr> <tr> <td><input type="radio"/></td> <td>0</td> <td><input checked="" type="radio"/></td> <td>1</td> </tr> <tr> <td><input checked="" type="radio"/></td> <td>2</td> <td><input checked="" type="radio"/></td> <td>2</td> </tr> <tr> <td><input checked="" type="radio"/></td> <td>2</td> <td><input checked="" type="radio"/></td> <td>2</td> </tr> <tr> <td colspan="2"><hr/></td> <td colspan="2"><hr/></td> </tr> <tr> <td colspan="2">4</td> <td colspan="2">5</td> </tr> </table>	<input type="radio"/>	0	<input type="radio"/>	0	<input type="radio"/>	0	<input checked="" type="radio"/>	1	<input checked="" type="radio"/>	2	<input checked="" type="radio"/>	2	<input checked="" type="radio"/>	2	<input checked="" type="radio"/>	2	<hr/>		<hr/>		4		5	
<input type="radio"/>	0	<input type="radio"/>	0																							
<input type="radio"/>	0	<input checked="" type="radio"/>	1																							
<input checked="" type="radio"/>	2	<input checked="" type="radio"/>	2																							
<input checked="" type="radio"/>	2	<input checked="" type="radio"/>	2																							
<hr/>		<hr/>																								
4		5																								

Increment size is 1A.

2.3.6.4 Preprogrammed charge voltage (default: Exide Dryfit)

A number of preprogrammed charge voltages tailored to specific battery types simplifies the process of setting the absorption/ float voltage and maximum absorption time:

	Battery type	Absorption voltage			Float voltage			Maximum absorption time
0	User-specified							
1 (default)	Exide Dryfit A200 Gel	14.4V	28.8V	57.6V	13.8V/ 13.2V	27.6V/ 26.4V	55.2V/ 52.8V	4 hours
2	Traction (tubular cell)	15.0V	30.0V	60.0V	13.8V/ 13.2V	27.6V/ 26.4V	55.2V/ 52.8V	6 hours
3	Semi Traction ¹ (flat plate)	14.4V	28.8V	57.6V	14.0V/ 13.2V	28.0V/ 26.4V	56.0V/ 52.8V	5 hours
4	Low antimony ¹	14.8V	29.6V	59.2V	14.0V/ 13.2V	28.0V/ 26.4V	56.0V/ 52.8V	5 hours

¹The optimal absorption voltage for flat plate lead acid batteries is subject to mechanical and chemical properties. Batteries with high antimony content can typically be charged with a lower absorption voltage than batteries with low antimony content. (please refer to our book "Electricity on Board" downloadable from our website www.victronenergy.com)

The default charge current setting is 75% of the maximum charge current. This current will be too high for most applications. For most battery types the optimal charge current is 0.1-0.2x the battery capacity.

Set the DS 3-7	Set the battery type	Example										
DS-8 <input type="text"/> DS-7 <input type="text"/> on DS-6 <input type="text"/> on DS-5 <input type="text"/> off DS-4 <input type="text"/> off DS-3 <input type="text"/> on DS-2 <input type="text"/> DS-1 <input type="text"/>	Determine the battery type used. Determine the setting numbers with the aid of the table. Press the keys until the required LED indication is displayed. NOTE: 0 cannot be selected but will be displayed if the absorption voltage, the float voltage or the absorption time is changed.	Required: the battery type is Victory: Setting number = 4. LED indication = <table border="1" style="margin-left: 20px;"> <tr> <td><input type="radio"/> 0</td> <td><input type="radio"/> 0</td> </tr> <tr> <td><input type="radio"/> 0</td> <td><input type="radio"/> 0</td> </tr> <tr> <td><input type="radio"/> 0</td> <td><input checked="" type="radio"/> 2</td> </tr> <tr> <td><input type="radio"/> 0</td> <td><input checked="" type="radio"/> 2</td> </tr> <tr> <td>0</td> <td>4</td> </tr> </table>	<input type="radio"/> 0	<input type="radio"/> 0	<input type="radio"/> 0	<input type="radio"/> 0	<input type="radio"/> 0	<input checked="" type="radio"/> 2	<input type="radio"/> 0	<input checked="" type="radio"/> 2	0	4
<input type="radio"/> 0	<input type="radio"/> 0											
<input type="radio"/> 0	<input type="radio"/> 0											
<input type="radio"/> 0	<input checked="" type="radio"/> 2											
<input type="radio"/> 0	<input checked="" type="radio"/> 2											
0	4											

The default setting is the Exide Dryfit A200 battery. Contact your battery supplier for the correct charge voltages and change the voltage settings if required.

2.3.6.5 Absorption Voltage

The absorption voltage can be set at 12-16/ 24-32/ 48-64V. The battery, the T-sense and V-sense must be disconnected during setting.

Set the DS 3-7	Set the absorption voltage	Example																				
DS-8 <input type="text"/> DS-7 <input type="text" value="off"/> DS-6 <input type="text" value="off"/> DS-5 <input type="text" value="off"/> DS-4 <input type="text" value="off"/> DS-3 <input type="text" value="off"/> DS-2 <input type="text"/> DS-1 <input type="text"/>	Determine the required absorption voltage V_q . Determine the setting number. $Scale = 0.1V$ $Offset = 12/24V$ $Setting\ number = (V_q - 24)/0.1$ Determine the LED indication. Press the pushbuttons until the required LED indication is displayed.	Required: absorption voltage is 28.5V. Setting number = $(28.5 - 24)/0.1 = 45$. LED indication = <table border="1" style="margin-left: 20px;"> <tr> <td><input type="radio"/></td><td>0</td> <td><input type="radio"/></td><td>0</td> </tr> <tr> <td><input type="radio"/></td><td>0</td> <td><input checked="" type="radio"/></td><td>1</td> </tr> <tr> <td><input checked="" type="radio"/></td><td>2</td> <td><input checked="" type="radio"/></td><td>2</td> </tr> <tr> <td><input checked="" type="radio"/></td><td>2</td> <td><input checked="" type="radio"/></td><td>2</td> </tr> <tr> <td></td><td><u>4</u></td> <td></td><td><u>5</u></td> </tr> </table>	<input type="radio"/>	0	<input type="radio"/>	0	<input type="radio"/>	0	<input checked="" type="radio"/>	1	<input checked="" type="radio"/>	2	<input checked="" type="radio"/>	2	<input checked="" type="radio"/>	2	<input checked="" type="radio"/>	2		<u>4</u>		<u>5</u>
<input type="radio"/>	0	<input type="radio"/>	0																			
<input type="radio"/>	0	<input checked="" type="radio"/>	1																			
<input checked="" type="radio"/>	2	<input checked="" type="radio"/>	2																			
<input checked="" type="radio"/>	2	<input checked="" type="radio"/>	2																			
	<u>4</u>		<u>5</u>																			

Increment size is 0.05 V.

2.3.6.6 Absorption Time/ Maximum Absorption Time (default: 4 hours)

This setting defines the absorption period in the case of the fixed charging characteristic and the maximum absorption time in the case of the adaptive charging characteristic. The (maximum) absorption time can be set from 1 to 8 hours.

Set the DS 3-7	Set the (maximum) absorption time	Example																				
DS-8 <input type="text"/> DS-7 <input type="text" value="on"/> DS-6 <input type="text" value="off"/> DS-5 <input type="text" value="on"/> DS-4 <input type="text" value="on"/> DS-3 <input type="text" value="off"/> DS-2 <input type="text"/> DS-1 <input type="text"/>	Determine the required (maximum) absorption time T_q . Determine the setting number. $Scale = 1\ hour$ $Offset = 0$ $Setting\ number = T_q$ Determine the LED indication. Press the pushbuttons until the required LED indication is displayed.	Required: (maximum) absorption time is 4 hours. Setting number = 4. LED indication = <table border="1" style="margin-left: 20px;"> <tr> <td><input type="radio"/></td><td>0</td> <td><input type="radio"/></td><td>0</td> </tr> <tr> <td><input type="radio"/></td><td>0</td> <td><input type="radio"/></td><td>0</td> </tr> <tr> <td><input type="radio"/></td><td>0</td> <td><input checked="" type="radio"/></td><td>2</td> </tr> <tr> <td><input type="radio"/></td><td>0</td> <td><input checked="" type="radio"/></td><td>2</td> </tr> <tr> <td></td><td><u>0</u></td> <td></td><td><u>4</u></td> </tr> </table>	<input type="radio"/>	0	<input type="radio"/>	0	<input type="radio"/>	0	<input type="radio"/>	0	<input type="radio"/>	0	<input checked="" type="radio"/>	2	<input type="radio"/>	0	<input checked="" type="radio"/>	2		<u>0</u>		<u>4</u>
<input type="radio"/>	0	<input type="radio"/>	0																			
<input type="radio"/>	0	<input type="radio"/>	0																			
<input type="radio"/>	0	<input checked="" type="radio"/>	2																			
<input type="radio"/>	0	<input checked="" type="radio"/>	2																			
	<u>0</u>		<u>4</u>																			

Increments are 1 hour.

2.3.6.7 Float Voltage

The float voltage can be set at 12-16/ 24-32/ 48-64V. Battery, the T-sense and V-sense must be disconnected during setting.

Set the DS 3-7	Set the float voltage	Example																				
DS-8 <input type="text"/> DS-7 <input type="text"/> on DS-6 <input type="text"/> off DS-5 <input type="text"/> off DS-4 <input type="text"/> off DS-3 <input type="text"/> off DS-2 <input type="text"/> DS-1 <input type="text"/>	Determine the required float voltage V_q . Determine the setting number. $Scale = 0.1V$ $Minimum = 12/24V$ $Setting\ number = (V_q - 24)/0.1$ Determine the LED indication. Press the pushbuttons until the required LED indication is displayed.	Required: float voltage is 28.5V. $Setting\ number = (28.5 - 24)/0.1 = 45$. LED indication = <table border="1" style="display: inline-table; vertical-align: middle;"> <tr><td><input type="radio"/></td><td>0</td><td><input type="radio"/></td><td>0</td></tr> <tr><td><input type="radio"/></td><td>0</td><td><input checked="" type="radio"/></td><td>1</td></tr> <tr><td><input checked="" type="radio"/></td><td>2</td><td><input checked="" type="radio"/></td><td>2</td></tr> <tr><td><input checked="" type="radio"/></td><td>2</td><td><input checked="" type="radio"/></td><td>2</td></tr> <tr><td colspan="2" style="border-top: 1px solid black;">4</td><td colspan="2" style="border-top: 1px solid black;">5</td></tr> </table>	<input type="radio"/>	0	<input type="radio"/>	0	<input type="radio"/>	0	<input checked="" type="radio"/>	1	<input checked="" type="radio"/>	2	<input checked="" type="radio"/>	2	<input checked="" type="radio"/>	2	<input checked="" type="radio"/>	2	4		5	
<input type="radio"/>	0	<input type="radio"/>	0																			
<input type="radio"/>	0	<input checked="" type="radio"/>	1																			
<input checked="" type="radio"/>	2	<input checked="" type="radio"/>	2																			
<input checked="" type="radio"/>	2	<input checked="" type="radio"/>	2																			
4		5																				

Increment size is 0.05 V.

2.3.6.8 Repeated Absorption

After each charging cycle, the charger will be switched back to the high charging current after a pre-set time, following the float phase. This switch back action is called "repeated absorption mode", see Appendix C.

Repeated Absorption Time (default: 1 hour)



The repeated absorption time can be set at 1 – 72 quarters of an hour.

Set the DS 3-7	Set the repeated absorption time	Example																				
DS-8 <input type="text"/> DS-7 <input type="text"/> on DS-6 <input type="text"/> on DS-5 <input type="text"/> on DS-4 <input type="text"/> off DS-3 <input type="text"/> off DS-2 <input type="text"/> DS-1 <input type="text"/>	Determine the required Repeated absorption time T_q in quarters of an hour. Determine the setting number. $Scale = 1\ quarter\ of\ an\ hour$ $Offset = 0$ $Setting\ number = T_q$ Determine the LED indication. Press the pushbuttons until the required LED indication is displayed.	Required: Repeated absorption time is 1 hour. $Setting\ number = 1\ hour = 4\ quarters\ of\ an\ hour$ LED indication = <table border="1" style="display: inline-table; vertical-align: middle;"> <tr><td><input type="radio"/></td><td>0</td><td><input type="radio"/></td><td>0</td></tr> <tr><td><input type="radio"/></td><td>0</td><td><input type="radio"/></td><td>0</td></tr> <tr><td><input type="radio"/></td><td>0</td><td><input checked="" type="radio"/></td><td>2</td></tr> <tr><td><input type="radio"/></td><td>0</td><td><input checked="" type="radio"/></td><td>2</td></tr> <tr><td colspan="2" style="border-top: 1px solid black;">0</td><td colspan="2" style="border-top: 1px solid black;">4</td></tr> </table>	<input type="radio"/>	0	<input type="radio"/>	0	<input type="radio"/>	0	<input type="radio"/>	0	<input type="radio"/>	0	<input checked="" type="radio"/>	2	<input type="radio"/>	0	<input checked="" type="radio"/>	2	0		4	
<input type="radio"/>	0	<input type="radio"/>	0																			
<input type="radio"/>	0	<input type="radio"/>	0																			
<input type="radio"/>	0	<input checked="" type="radio"/>	2																			
<input type="radio"/>	0	<input checked="" type="radio"/>	2																			
0		4																				

Increment size is a quarter of an hour.

Repeated Absorption Interval (default: 7 days)

The repeated absorption interval, can be set at 1 – 45 days.

Set the DS 3-7	Set the repeated absorption interval	Example																				
DS-8 <input type="text"/> DS-7 <input type="text" value="off"/> DS-6 <input type="text" value="off"/> DS-5 <input type="text" value="off"/> DS-4 <input type="text" value="on"/> DS-3 <input type="text" value="off"/> DS-2 <input type="text"/> DS-1 <input type="text"/>	Determine the required reduced float time T_q . Determine the setting number. <i>Scale = 1 day</i> <i>Offset = 0</i> <i>Setting number = T_q</i> Determine the LED indication. Press the pushbuttons until the required LED indication is displayed.	Required: reduced float time is 1 week. Setting number = 7. LED indication = <table border="1" style="margin-left: 20px;"> <tr> <td><input type="radio"/></td> <td>0</td> <td></td> <td>1</td> </tr> <tr> <td><input type="radio"/></td> <td>0</td> <td><input checked="" type="radio"/></td> <td>2</td> </tr> <tr> <td><input type="radio"/></td> <td>0</td> <td><input checked="" type="radio"/></td> <td>2</td> </tr> <tr> <td><input type="radio"/></td> <td>0</td> <td><input checked="" type="radio"/></td> <td>2</td> </tr> <tr> <td colspan="3" style="border-top: 1px solid black; border-bottom: 1px solid black; text-align: center;">0</td> <td style="border-top: 1px solid black; border-bottom: 1px solid black; text-align: center;">7</td> </tr> </table>	<input type="radio"/>	0		1	<input type="radio"/>	0	<input checked="" type="radio"/>	2	<input type="radio"/>	0	<input checked="" type="radio"/>	2	<input type="radio"/>	0	<input checked="" type="radio"/>	2	0			7
<input type="radio"/>	0		1																			
<input type="radio"/>	0	<input checked="" type="radio"/>	2																			
<input type="radio"/>	0	<input checked="" type="radio"/>	2																			
<input type="radio"/>	0	<input checked="" type="radio"/>	2																			
0			7																			

Increments are 1 day.

2.3.7 Special Settings (default: on)

2.3.7.1 Bulk Protection On/ Off

If the charger has not reached the absorption voltage after 10 hours' charging in the bulk phase, the battery may be defective. In order to prevent further damage, the charger will automatically cut out after 10 hours' bulk. The "bulk" LED will start to flash. This safety cut out can be switched off.

Set the DS 3-7	Switch the bulk cut-out to on or off	Example										
DS-8 <input type="checkbox"/> DS-7 <input type="checkbox"/> off DS-6 <input type="checkbox"/> on DS-5 <input type="checkbox"/> off DS-4 <input type="checkbox"/> on DS-3 <input type="checkbox"/> off DS-2 <input type="checkbox"/> DS-1 <input type="checkbox"/>	Determine whether the bulk cut out should be switched on or off. The default is On. The left-hand LED column is for On. The right-hand LED column is for Off. Press the pushbuttons until the required LED indication is displayed.	Required: bulk cut out is off. LED indication = <table border="1" style="margin-left: 20px;"> <thead> <tr> <th>On</th> <th>Off</th> </tr> </thead> <tbody> <tr><td><input type="checkbox"/></td><td><input type="checkbox"/></td></tr> <tr><td><input type="checkbox"/></td><td><input type="checkbox"/></td></tr> <tr><td><input type="checkbox"/></td><td><input type="checkbox"/></td></tr> <tr><td><input type="checkbox"/></td><td><input checked="" type="checkbox"/></td></tr> </tbody> </table>	On	Off	<input type="checkbox"/>	<input type="checkbox"/>	<input type="checkbox"/>	<input type="checkbox"/>	<input type="checkbox"/>	<input type="checkbox"/>	<input type="checkbox"/>	<input checked="" type="checkbox"/>
On	Off											
<input type="checkbox"/>	<input type="checkbox"/>											
<input type="checkbox"/>	<input type="checkbox"/>											
<input type="checkbox"/>	<input type="checkbox"/>											
<input type="checkbox"/>	<input checked="" type="checkbox"/>											

2.3.7.2 AC Waveform Check (default: on)

The Phoenix Multi checks if the mains voltage has not only the correct voltage, but also the correct shape. **When the Phoenix Multi does not function properly on a generator this function can be disabled.**

Set the DS 3-7	Switch the Mains Voltage Check to on or off	Example										
DS-8 <input type="checkbox"/> DS-7 <input type="checkbox"/> off DS-6 <input type="checkbox"/> on DS-5 <input type="checkbox"/> off DS-4 <input type="checkbox"/> off DS-3 <input type="checkbox"/> on DS-2 <input type="checkbox"/> DS-1 <input type="checkbox"/>	Determine whether the Mains Waveform Check should be switched on or off. The default is On. The left-hand LED column is for On. The right-hand LED column is for Off. Press the pushbuttons until the required LED indication is displayed.	Required: Mains Waveform Check is off. LED indication = <table border="1" style="margin-left: 20px;"> <thead> <tr> <th>On</th> <th>Off</th> </tr> </thead> <tbody> <tr><td><input type="checkbox"/></td><td><input type="checkbox"/></td></tr> <tr><td><input type="checkbox"/></td><td><input type="checkbox"/></td></tr> <tr><td><input type="checkbox"/></td><td><input type="checkbox"/></td></tr> <tr><td><input type="checkbox"/></td><td><input checked="" type="checkbox"/></td></tr> </tbody> </table>	On	Off	<input type="checkbox"/>	<input type="checkbox"/>	<input type="checkbox"/>	<input type="checkbox"/>	<input type="checkbox"/>	<input type="checkbox"/>	<input type="checkbox"/>	<input checked="" type="checkbox"/>
On	Off											
<input type="checkbox"/>	<input type="checkbox"/>											
<input type="checkbox"/>	<input type="checkbox"/>											
<input type="checkbox"/>	<input type="checkbox"/>											
<input type="checkbox"/>	<input checked="" type="checkbox"/>											

2.3.7.3 PowerControl – Dealing with limited generator or shore side power

The Multi is a very powerful battery charger. It will therefore draw a lot of current from the generator or shore side supply (nearly 10 A per Multi at 230 VAC). With the Phoenix Multi Control Panel a maximum generator or shore current can be set. The Multi will then take account of other AC loads and use whatever is extra for charging, thus preventing the generator or shore supply from being overloaded.

It is also possible to set the max. generator/ shore current internally.
The generator/ shore current can be set at 2 - 16A (optional 4 – 30A).

Set the DS 3-7	Set the shore current	Example																				
DS-8 <input type="text"/> DS-7 <input type="text" value="off"/> DS-6 <input type="text" value="on"/> DS-5 <input type="text" value="on"/> DS-4 <input type="text" value="off"/> DS-3 <input type="text" value="off"/> DS-2 <input type="text"/> DS-1 <input type="text"/>	Determine the required shore current limitation I_q . Determine the setting number. $Scale = 1A$ $Offset = 0$ $Setting\ number = (I_q)/1$ Determine the LED indication. Press the pushbuttons until the required LED indication is displayed.	Required: shore current limitation is 16A. Setting number = 16. LED indication = <table border="1" style="margin-left: 20px;"> <tr> <td><input type="radio"/></td><td>0</td><td><input type="radio"/></td><td>0</td> </tr> <tr> <td><input type="radio"/></td><td>0</td><td><input checked="" type="radio"/></td><td>2</td> </tr> <tr> <td><input type="radio"/></td><td>0</td><td><input checked="" type="radio"/></td><td>2</td> </tr> <tr> <td><input checked="" type="radio"/></td><td>1</td><td><input checked="" type="radio"/></td><td>2</td> </tr> <tr> <td colspan="2" style="border-top: 1px solid black;">1</td> <td colspan="2" style="border-top: 1px solid black;">6</td> </tr> </table>	<input type="radio"/>	0	<input type="radio"/>	0	<input type="radio"/>	0	<input checked="" type="radio"/>	2	<input type="radio"/>	0	<input checked="" type="radio"/>	2	<input checked="" type="radio"/>	1	<input checked="" type="radio"/>	2	1		6	
<input type="radio"/>	0	<input type="radio"/>	0																			
<input type="radio"/>	0	<input checked="" type="radio"/>	2																			
<input type="radio"/>	0	<input checked="" type="radio"/>	2																			
<input checked="" type="radio"/>	1	<input checked="" type="radio"/>	2																			
1		6																				

Increment size is 1A.

The remote control panel setting overrides the internal setting.

2.3.7.4 PowerAssist – Boosting the capacity of shore or generator power (default: on)

The feature that distinguishes the Phoenix MultiPlus from the standard Multi is PowerAssist. This feature takes the principle of PowerControl to a further dimension allowing the MultiPlus to supplement the capacity of the alternative source. Where peak power is so often required only for a limited period, it is possible to reduce the size of generator needed or conversely enable more to be achieved from the typically limited shore connection. When the load reduces, the spare power is used to recharge the battery.

Note 1: minimum shore current 2 A or generator capacity 2.5 kW required per MultiPlus.

Note 2: Some modern AC generators use a static inverter to generate the AC output. Some of these generators also reduce rpm when operating with reduced load. By enabling the

Dynamic Current Limit function (VEConfigure) the MultiPlus can be used to assist the generator when suddenly a high load is connected.

Set the DS 3-7	Switch PowerAssist on or off	Example										
DS-8 <input type="checkbox"/> DS-7 <input checked="" type="checkbox"/> on DS-6 <input type="checkbox"/> off DS-5 <input checked="" type="checkbox"/> on DS-4 <input type="checkbox"/> off DS-3 <input type="checkbox"/> off DS-2 <input type="checkbox"/> DS-1 <input type="checkbox"/>	Determine whether PowerAssist support should be on or off. The default is Off. The left-hand LED column is for Off. The right-hand LED column is for On. Press the pushbuttons until the required LED indication is displayed.	Required: PowerAssist is on. LED indication = <table border="1" style="margin-left: 20px;"> <tr> <td>Off</td> <td>On</td> </tr> <tr> <td><input type="checkbox"/></td> <td><input type="checkbox"/></td> </tr> <tr> <td><input type="checkbox"/></td> <td><input type="checkbox"/></td> </tr> <tr> <td><input type="checkbox"/></td> <td><input type="checkbox"/></td> </tr> <tr> <td><input type="checkbox"/></td> <td><input checked="" type="checkbox"/></td> </tr> </table>	Off	On	<input type="checkbox"/>	<input type="checkbox"/>	<input type="checkbox"/>	<input type="checkbox"/>	<input type="checkbox"/>	<input type="checkbox"/>	<input type="checkbox"/>	<input checked="" type="checkbox"/>
Off	On											
<input type="checkbox"/>	<input type="checkbox"/>											
<input type="checkbox"/>	<input type="checkbox"/>											
<input type="checkbox"/>	<input type="checkbox"/>											
<input type="checkbox"/>	<input checked="" type="checkbox"/>											

2.3.7.5 3-phase Setting (default: off)

Three identical units can't be interconnected for a 3-phase system, in accordance with Appendix 0. The batteries must be connected in accordance with Appendix E or F. A number of settings are then required for each unit.

Firstly, all units must be set for 3-phase operation.

Set the DS 3-7	Switch 3-phase operation on or off	Example										
DS-8 <input type="checkbox"/> DS-7 <input type="checkbox"/> on DS-6 <input type="checkbox"/> on DS-5 <input type="checkbox"/> off DS-4 <input type="checkbox"/> on DS-3 <input type="checkbox"/> off DS-2 <input type="checkbox"/> DS-1 <input type="checkbox"/>	Determine whether 3-phase operation should be on or off. The default is Off. The left-hand LED column is for Off. The right-hand LED column is for On. Press the pushbuttons until the required LED indication is displayed.	Required: 3-phase operation is on. LED indication = <table border="1" style="margin-left: 20px;"> <thead> <tr> <th>Off</th> <th>On</th> </tr> </thead> <tbody> <tr><td><input type="checkbox"/></td><td><input type="checkbox"/></td></tr> <tr><td><input type="checkbox"/></td><td><input type="checkbox"/></td></tr> <tr><td><input type="checkbox"/></td><td><input type="checkbox"/></td></tr> <tr><td><input type="checkbox"/></td><td><input checked="" type="checkbox"/></td></tr> </tbody> </table>	Off	On	<input type="checkbox"/>	<input type="checkbox"/>	<input type="checkbox"/>	<input type="checkbox"/>	<input type="checkbox"/>	<input type="checkbox"/>	<input type="checkbox"/>	<input checked="" type="checkbox"/>
Off	On											
<input type="checkbox"/>	<input type="checkbox"/>											
<input type="checkbox"/>	<input type="checkbox"/>											
<input type="checkbox"/>	<input type="checkbox"/>											
<input type="checkbox"/>	<input checked="" type="checkbox"/>											

One of the three units must be set as the "master" following this setting.. No further settings are required for the other units.

Set the DS 3-7	Set the master/ slave	Example										
DS-8 <input type="checkbox"/> DS-7 <input type="checkbox"/> off DS-6 <input type="checkbox"/> off DS-5 <input type="checkbox"/> on DS-4 <input type="checkbox"/> on DS-3 <input type="checkbox"/> off DS-2 <input type="checkbox"/> DS-1 <input type="checkbox"/>	Determine master or slave. The default is slave. The left-hand LED column is for slave. The right-hand LED column is for the master. Press the pushbuttons until the required LED indication is displayed.	Required: this unit is the master. LED indication = <table border="1" style="margin-left: 20px;"> <thead> <tr> <th>slave</th> <th>master</th> </tr> </thead> <tbody> <tr><td><input type="checkbox"/></td><td><input type="checkbox"/></td></tr> <tr><td><input type="checkbox"/></td><td><input type="checkbox"/></td></tr> <tr><td><input type="checkbox"/></td><td><input type="checkbox"/></td></tr> <tr><td><input type="checkbox"/></td><td><input checked="" type="checkbox"/></td></tr> </tbody> </table>	slave	master	<input type="checkbox"/>	<input type="checkbox"/>	<input type="checkbox"/>	<input type="checkbox"/>	<input type="checkbox"/>	<input type="checkbox"/>	<input type="checkbox"/>	<input checked="" type="checkbox"/>
slave	master											
<input type="checkbox"/>	<input type="checkbox"/>											
<input type="checkbox"/>	<input type="checkbox"/>											
<input type="checkbox"/>	<input type="checkbox"/>											
<input type="checkbox"/>	<input checked="" type="checkbox"/>											

2.4 Settings that can be changed with VEConfigure

All settings discussed in the previous paragraph can also, and much more conveniently, be changed with VEConfigure

The following settings can be changed with VEConfigure only (see VEConfigure for a complete list):

- **Ground relay (default: on).** When running on inverter the output neutral is connected to the output ground wire and therefore also the chassis. This is to ensure proper functioning of a GFCI (Ground Fault Circuit Interrupter), to be installed on the AC output of the MultiPlus. In an isolated system the ground relay should be disabled. Proper isolation of both phase and neutral from ground should then be monitored with an isolation watch system.
- **Dynamic current limit (default: off).** Some modern AC generators use a static inverter to generate the AC output. Some of these generators also reduce rpm when operating with reduced load. By enabling the Dynamic Current Limit function (VEConfigure) the MultiPlus can be used to assist the generator when suddenly a high load is connected.
- **Alarm Relay / Virtual Switch (default: disabled)**
A programmable relay is available in both the Phoenix Inverter and Multi/MultiPlus. This relay can be used for remote alarm and other purposes (a. o. generator start signal). The relay can be programmed with VEConfigure.
- **AC input frequency tracking range:** see section 2.3.4.

2.5 Maintenance

The Phoenix Multi does not require specific maintenance. Annual checking of all connections and eventually removal of dust suffices. Protect the product from humidity and oil fumes and keep it clean.

3. TROUBLE SHOOTING TABLE

Proceed as follows for quick detection of common faults.
DC loads must be disconnected from the batteries and the AC loads must be disconnected from the inverter before the inverter and/ or battery charger is tested.

Consult your Victron Energy dealer if the fault cannot be resolved.

Problem	Cause	Solution
The inverter fails to operate when switched on.	The battery voltage is too high or too low.	Ensure that the battery voltage is within the correct value.
The "low battery" LED flashes.	The battery voltage is low.	Charge the battery or check the battery connections.
The "low battery" LED on.	The inverter cuts out because the battery voltage is too low.	Charge the battery or check the battery connections.
The "overload" LED flashes.	The load on the inverter is higher than the nominal load.	reduce the load.
The "overload" LED on.	The inverter cuts out due to excessive load.	reduce the load.
The "temperature" LED flashes or is on.	The ambient temperature is too high, or the load is excessive.	Place the inverter in a cool and well-ventilated room, or reduce the load.
The "low battery" and "overload" LEDs flash alternately.	Low battery voltage and excessive load.	Charge the batteries, reduce the load or install batteries with a higher capacity. Use shorter and/ or thicker battery cables.
The "low battery" and "overload" LEDs flash simultaneously.	Voltage ripple on the DC input exceeds 1.25Vrms.	Check the battery cables and terminals. Check the battery capacity; increase if necessary.
The "low battery" and "overload" LEDs are on.	The inverter cuts out as a result of excessive voltage ripple on the DC input.	Install batteries with a higher capacity. Use shorter and/ or thicker battery cables and reset the inverter (switch off and on again).
One LED alarm is on and the second LED is flashing	The inverter did cut out as a result of the illuminated alarm indication (LED). The flashing LED indicates that the inverter also nearly did cut out as a result of the relevant alarm.	Check the table for the appropriate course of action.

Problem	Cause	Solution
The charger is not functioning	The mains voltage or mains frequency is out of range.	Ensure that the mains voltage is between 185 Vac and 265 Vac, and that the frequency matches the setting.
	The thermal circuit breaker has tripped.	Reset the 16 A thermal circuit breaker.
The battery is not being charged fully.	Incorrect charging current.	Set the charging current at between 0.1 and 0.2x battery capacity.
	A defective battery connection.	Check the battery terminals.
	The absorption voltage has been set to an incorrect value.	Adjust the absorption voltage to the correct value.
	The float voltage has been set to an incorrect value.	Adjust the float voltage to the correct value.
	The DC fuse is defective.	Replace the DC fuse.
The battery is overcharged.	The absorption voltage has been set to an incorrect value.	Adjust the absorption voltage to the correct value.
	The float voltage has been set to an incorrect value.	Adjust the float voltage to the correct value.
	A defective battery.	Replace the battery.
	The battery is too small.	Reduce the charging current or use a battery with a higher capacity.
	The battery is too hot.	Connect a temperature sensor.
Battery charge current drops to 0 when the absorption voltage is reached	Alt. 1: Battery over temperature (> 50°C)	<ul style="list-style-type: none"> - Allow battery to cool down - Place battery in a cool environment - Check for shorted cells
	Alt 2: Battery temperature sensor faulty	Unplug battery temperature sensor from the Multi. Reset the Multi by switching it off, then wait for 4 seconds and switch it on again If the Multi now charges normally, the battery temperature sensor is faulty and needs to be replaced

4. TECHNICAL DATA

Phoenix Multi/MultiPlus	12/2000/100	12/3000/120	24/2000/60	24/3000/70	48/3000/35
INVERTER					
Input voltage range (V DC)	9,5-16,1	9,5-16,1	19,0-32,2	19,0-32,2	38,0-64,4
Output voltage (V AC)	230 ± 2%				
Frequency (Hz) (1)	50 ± 0,1%				
Cont. output power at 25 °C (VA) (5)	2000	3000	2000	3000	3000
Cont. output power at 25 °C (W)	1800	2500	1800	2500	2500
Cont. output power at 40 °C (W)	1400	1600	1500	2000	2000
Peak power (W)	4000	4500	4000	6000	6000
Maximum efficiency (%)	93	93	94	94	95
Zero-load (economy) power (W)	6	6	6	6	10
CHARGER					
Input voltage range (V AC)	187-265				
Input frequency (Hz)	45 - 55				
Power factor	1				
Charge voltage 'absorption' (V DC)	14,4	14,4	28,8	28,8	57,6
Charge voltage 'float' (V DC)	13,8	13,8	27,6	27,6	55,2
Storage mode (V DC)	13,2	13,2	26,4	26,4	52,8
Charge current house batt. (A) (4)	100	120	60	70	35
Charge current starter batt. (A)	4	4	4	4	4
Battery capacity (Ah)	300-1000	400-1200	150-600	200-700	100-400
Battery temperature sensor	√	√	√	√	√

GB

NL

F

D

Appendix

Phoenix Multi/MultiPlus	12/2000/100	12/3000/120	24/2000/60	24/3000/70	48/3000/35
GENERAL					
Multi purpose relay	√ (6)				
Forced cooling	√				
Protection (2)	a - h				
Operating temp. range	-20 to +50°C				
Humidity (non condensing)	max 95%				
ENCLOSURE					
Material & Colour	aluminium (blue RAL 5012)				
Battery-connection	M8 studs				
230 V AC-connection	screw-clamp 2,5 mm ²				
Protection category	IP 21				
Weight (kg)	18	18	18	18	18
Dimensions (hxwx d in mm)	362x258x218				
STANDARDS					
Safety	EN 60335-1, EN 60335-2-29				
Emission	EN 50081-1, EN55014, EN 61000-3-2, EN 61000-3-3				
Immunity	EN 55014-2				
Automotive Directive	95/54/EC				n. a.

1) Can be adjusted to 60 Hz

2) Protection

a. Output short circuit

b. Overload

c. Battery voltage too high

d. Battery voltage too low

e. Battery reverse polarity detection

f. 230 V AC on inverter output

g. Input voltage ripple too high

h. Temperature too high

3) Not available in MultiPlus version

4) At 25 °C ambient

5) Non linear load, crest factor 3:1

6) Multipurpose relay which can be set for general alarm, DC under voltage or genset start signal function

1. INSTALLATIE



Dit product mag alleen door een gekwalificeerde elektrotechnicus worden geïnstalleerd.

GB

NL

F

D

Appendix

1.1 Inhoud van de doos

De doos van de Phoenix Multi bevat de volgende zaken:

- Phoenix Multi.
- Gebruikershandleiding.
- Installatiehandleiding.
- Zakje met aansluitmateriaal met daarin:
 - Temperatuursensor.
 - Zekering. (Mega fuse)
 - Vier moeren M8.
 - Vier sluitringen M8.
 - Vier veerringen M8.
 - Waarschuwingsticker laadstroom.

1.2 Locatie

De Phoenix Multi dient in een droge, goed geventileerde ruimte te worden geïnstalleerd zo dicht mogelijk bij de accu's. Rondom het apparaat dient een ruimte van tenminste 50mm te worden vrijgehouden voor koeling.



Een te hoge omgevingstemperatuur heeft de volgende consequenties:

- Kortere levensduur.
- Lagere laadstroom.
- Lager piek vermogen of geheel afschakelen van de omvormer.

Plaats het apparaat nooit direct boven de accu's.

De Phoenix Multi is geschikt voor wandmontage. Voor de montage zijn aan de achterzijde van de behuizing gaten aangebracht, zie appendix B.

Het apparaat kan zowel horizontaal als verticaal gemonteerd worden maar verticaal monteren is de beste montage. In deze positie is de koeling namelijk optimaal.



De binnenzijde van het apparaat dient ook na installatie goed bereikbaar te blijven.

Zorg ervoor dat de aansluitkabels zijn voorzien van zekeringen en stroomonderbrekers. Houd de afstand tussen de Phoenix Multi en de accu zo kort mogelijk om het spanningsverlies over de kabels tot een minimum te beperken.



Installeer het product in een hittebestendige omgeving. Voorkom daarom de aanwezigheid van bijvoorbeeld chemicaliën, kunststof onderdelen, gordijnen of ander textiel, etc. in de directe omgeving.

1.3 Benodigheden

- Een kruiskop schroevendraaier (PH 2) voor het verwijderen van het front.
- Een platte schroevendraaier (0,6x3,5) voor het aansluiten van de AC kabels.
- Een geïsoleerde pijpsleutel (13 mm) voor het vastdraaien van de aansluitbouten en de zekering.
- Twee accukabels (maximum lengte 6 meter) inclusief accuklemmen en kabelogen.
- Drie-aderige kabel.

1.4 Aansluiten accukabels

Om de capaciteit van de Phoenix Multi volledig te kunnen benutten dient uitsluitend gebruik te worden gemaakt van accu's met voldoende capaciteit en van accukabels met de juiste dikte. Zie tabel.

	12/2000/100	12/3000/120	24/2000/60	24/3000/70	48/3000/35
Aanbevolen accucapaciteit (Ah)	300–1000	400–1200	150–600	200–700	100–400
Aanbevolen kabeldikte (mm ²)					
0 – 5 m	70	90	40	50	35
5 – 10 m	100	120	70	90	70

Procedure

Ga bij het aansluiten van de accukabels als volgt te werk:



Om het gevaar van kortsluiting van de accu te voorkomen, dient u een geïsoleerde pijpsleutel te gebruiken. Voorkom kortsluiting van de accukabels.

- Draai de vier schroeven aan de voorzijde van de behuizing los en verwijder het front.
- Sluit de accukabels aan: de + (rood) aan de rechterzijde en de - (zwart) aan de linkerzijde, zie appendix A.
- Indien de accukabels van de Phoenix Multi zijn verwisseld (+ op – en – op +), zal de "reversed polarity" LED, die zich naast de aansluitbouten bevindt, branden.
- Als de "reversed polarity LED" brandt, ontkoppel de kabels en sluit ze op de juiste manier aan.
- Draai de aansluitingen vast na het plaatsen van het bijgeleverde bevestigingsmateriaal.
- Plaats de mega fuse uit het aansluitzakje op positie F4 en draai deze vast na het plaatsen van het bijgeleverde bevestigingsmateriaal.
- Draai de moeren stevig aan om overgangsweerstanden zo laag mogelijk te maken.

1.5 Aansluiten AC kabels

Dit is een product uit veiligheidsklasse I. (dat wordt geleverd met een aardklem ter beveiliging) **De in - en/ of uitgangsklemmen en/of het aard punt aan de buitenkant van het product moeten zijn voorzien van een ononderbreekbare aarding ter beveiliging. Zie hiervoor de volgende instructies:**

a) De Phoenix Inverter heeft een vrij zwevende uitgangsspanning. De behuizing **moet** geaard worden met het aard punt aan de buitenkant van het product. De N uitgang moet geaard worden om verzekerd te zijn van de goede werking van een aardlek schakelaar.



b) De Phoenix Multi / MultiPlus is voorzien van een aard relais (zie appendix) dat de **N uitgang automatisch met de behuizing verbint wanneer geen externe wisselspanning voeding beschikbaar is**. Wanneer een externe wisselspanning voeding wordt aangeboden zal het aard relais openen voordat het ingang veiligheids relais sluit (zie appendix). Dit is om goede werking van een op de uitgang aangesloten aardlekschakelaar te verzekeren.

- In een vaste installatie kan een ononderbreekbare aarding verzekerd worden met de aard draad van de wisselspanning ingang. Zoniet, dan moet de behuizing geaard worden.

- In een mobiele installatie (bijvoorbeeld met walstroom stekker) zal onderbreking van de walaansluiting tegelijk ook de aard verbinding verbreken. In dat geval moet de behuizing verbonden worden met het chassis (van het voertuig) of met de romp of aardplaat (van de boot).

- Op boten is de hierboven beschreven verbinding met de aarde van de walaansluiting i. h. a. niet aan te bevelen i. v. m. galvanische corrosie.

De oplossing hiervoor is plaatsing van een isolatie transformator.

Het klemmenblok bevindt zich op de printplaat, zie appendix A. De wal- of netaansluiting dient met behulp van een drie-aderige kabel op de Multi te worden aangesloten. Maak gebruik van een drie-aderige kabel met een soepele kern en een doorsnede van 2,5 of 4 mm². (type H05RN-F)

Procedure

Ga voor het aansluiten van de AC kabels als volgt te werk:

- De AC apparatuur kan direct op het klemmenblok met de tekst "AC-out" worden aangesloten met behulp van een drie-aderige kabel. De aansluitpunten zijn duidelijk gecodeerd. Van links naar rechts: "PE" (aarde), "N" (nulleider) en "L" (fase)
- De AC netspanning kan worden aangesloten op het klemmenblok met de tekst "AC-in". De aansluitpunten zijn duidelijk gecodeerd. "PE" (aarde) "N" (nulleider) en "L" (fase)

1.6 Aansluitopties

Naast de standaardaansluitingen kunnen er nog een aantal opties worden aangesloten.

1.6.1 Startaccu

De Phoenix Multi heeft een aansluiting voor het laden van een startaccu. Zie voor het aansluiten appendix A.

1.6.2 Voltage sense (Multi/ MultiPlus)

Voor het compenseren van eventuele kabel verliezen tijdens het laden kunnen er twee sense draden worden aangesloten. Gebruik tenminste 0,75mm² draad. Zie voor het aansluiten appendix A.

1.6.3 Temperatuursensor (Multi/ MultiPlus)

Voor het temperatuur gecompenseerd laden kan de bijgeleverde temperatuursensor worden aangesloten. (zie appendix A) De sensor is geïsoleerd en moet op de min pool van de accu worden gemonteerd.

1.6.4 Afstandsbediening

De Phoenix Multi is op twee manieren op afstand te bedienen.

- Met alleen een externe schakelaar.
- Met een afstandsbedieningspaneel.

Voor het aansluiten van de schakelaar zie appendix A.

Indien gebruik wordt gemaakt van alleen een externe schakelaar dient u met het volgende rekening te houden:

- Werkt alleen als de schakelaar van de Phoenix Multi op "on" staat.
- Mag niet worden aangesloten als er een afstandsbedieningspaneel is aangesloten.

Voor het aansluiten van een afstandsbedieningspaneel zie appendix A.

Indien gebruik wordt gemaakt van een afstandsbedieningspaneel dient u met het volgende rekening te houden:

- Werkt alleen als de schakelaar van de Phoenix Multi op "on" staat.

1.6.5 Extern relais (Multi/ MultiPlus)

De maximale stroom die doorgeschakeld kan worden is 16 A (optioneel 30A)

Indien het gewenst is om meer dan 16 Ampère door te schakelen kan een extern relais toegepast worden. Neem hiervoor contact op met uw leverancier.

1.6.6 Parallel schakelen

De Phoenix Multi is parallel te schakelen met meerdere identieke apparaten, zie appendix G. De accu's moeten aangesloten worden volgens appendix E of F. Het parallel schakelen biedt de mogelijkheid eenvoudig de vermogenscapaciteit te verhogen. Hiervoor wordt een verbinding tussen de apparaten gemaakt met behulp van een speciaal door Victron Energy te leveren kabel met aansluitschema.

Bij parallel schakelen moet aan de volgende voorwaarden voldaan worden:

- Schakel niet meer dan vijf apparaten parallel.
- Schakel alleen identieke apparaten parallel. (uitzondering: voor MultiPlus functionaliteit hoeft alleen de Master een MultiPlus te zijn)
- Zorg voor voldoende accucapaciteit.
- De voorgeschreven kabeldiktes (tussen accu en distributiepunt) moeten vermenigvuldigd worden met het aantal parallel te schakelen apparaten.
- Plaats de Multi's dicht bij elkaar, maar zorg voor minimaal 10 cm ventilatieruimte.
- Temperatuursensor, voltage sense en afstandsbediening dienen op de master aangesloten te worden.
- De kabels per apparaat dienen even lang te zijn. (AC en DC)

1.6.7 3-Fase schakelen

De Phoenix MultiPlus kan ook gebruikt worden in een 3-fase net, zie appendix O. De accu's moeten aangesloten worden volgens appendix E of F. Bij 3-fase schakelen moet aan de volgende voorwaarden voldaan worden:

- Schakel alleen identieke apparaten in 3-fase.
- Zorg voor voldoende accucapaciteit.
- Plaats de MultiPlus apparaten dicht bij elkaar, maar zorg voor voldoende ventilatieruimte.
- Temperatuursensor en voltage sense moeten bij voorkeur op alle drie apparaten aangesloten worden.
- Er kan één afstandsbediening aangesloten worden met behulp van splitters.

2. INSTELLINGEN



- Het wijzigen van de instellingen mag alleen worden uitgevoerd door een gekwalificeerde elektrotechnicus.
- Lees voor het wijzigen goed de instructies.
- Tijdens het instellen van de lader moeten alle verbindingen naar de accu losgekoppeld zijn van de Phoenix Multi.
- Geen niet-oplaadbare accu's gebruiken.
- Deze Phoenix Multi heeft een fabrieksinstelling voor het laden van Exide Dryfit A200 gel accu's. Zie voor de aanbevolen accucapaciteit paragraaf 0.
- Tijdens het laden moeten accu's in een droge, goed geventileerde ruimte staan.

2.1 Instelling algemeen

2.1.1 Instellen met druktoetsen en dipswitches

Een aantal instellingen kan gewijzigd worden door middel van druktoetsen en dipswitches. (zie appendix A)

Met de dipswitches activeert u de set-up en bepaalt u welke instelling gewijzigd wordt. Met de druktoetsen kunt u de waarde van deze instelling wijzigen.

Via de LED's kunt u de ingestelde waarde aflezen. Paragraaf 0 en 0 beschrijven hoe de LED's afgelezen worden.

2.1.2 Instellingen wijzigen met VEConfigure software

Alle instellingen kunnen gewijzigd worden met VEConfigure software

U kunt de VEConfigure software downloaden van www.victronenergy.com

2.2 Standaard (fabrieks-) instellingen

Systeem frequentie		50 Hz
Omvormer Voltage		230 Vac
Lader on/ off		on
Lader karakteristieken		Adaptive met BatterySafe mode
Laderstroom		75% van de maximum laadstroom
Accu Type Presets		type 1
Absorption Voltage		14.4/ 28.8/ 57.6 Vdc
Absorption Tijd/ Maximum Absorption Tijd		4 uur
Float Voltage		13.8/ 27.6/ 55.2 Vdc
Herhaalde Absorption Tijd		1 uur
Herhaalde Absorption Interval		7 dagen
Bulk Beveiliging		on
Sinusvorm Check		on
Generator/ Walstroom		16 A (optioneel: 30A)
PowerAssist (alleen MultiPlus)	on	
3-phase Instellingen	off	
Master/ Slave		Slave

(Om alle fabrieksinstellingen te herstellen moeten beide druktoetsen 3 seconden ingedrukt worden terwijl de set-up geactiveerd is)

2.3 Instellingen wijzigen met druktoetsen en dipswitches

2.3.1 Set-up activeren

<p>DS-8 on DS-7 DS-6 DS-5 DS-4 DS-3 DS-2 DS-1</p>	<p>DS-8 DS-7 DS-6 DS-5 DS-4 DS-3 DS-2 DS-1</p>	<p>DS-8 DS-7 DS-6 DS-5 DS-4 DS-3 DS-2 DS-1</p>	<p>DS-8 off DS-7 DS-6 DS-5 DS-4 DS-3 DS-2 DS-1</p>
Set-up activeren met DS8 op On	Instelling kiezen met DS3 t/m DS7 en nieuwe waarde instellen met druktoetsen	Sla de instellingen op door één van de schakelaars DS3 t/m DS7 te veranderen	Set-up verlaten met DS8 op Off

DS-1 en DS-2 zijn gereserveerd en dienen op Off gezet te worden.

LET OP: De nieuwe waarde wordt alleen opgeslagen als een andere instelling wordt geselecteerd. Als de set-up wordt verlaten zonder een andere instelling te kiezen, wordt de nieuwe waarde NIET opgeslagen. Dit biedt een ontsnappingsmogelijkheid indien de wijziging niet doorgevoerd moet worden.

GB

NL

F

D

Appendix

2.3.2 Aflezing LED's meervoudige keuze (Multi/ MultiPlus)

Aan de hand van de volgende formule kan bepaald worden wat de waarde van een instelling is:

$$\text{Ingestelde waarde} = \text{instelgetal} * \text{schaal} + \text{offset}$$

De 'offset' en de 'schaal' worden per instelling opgegeven.

Het instelgetal wordt op de volgende wijze via de LED's weergegeven:

De LED's zijn opgedeeld in 2 rijen van 4 LED's.

Iedere rij geeft de cijfers 0 - 9 weer.

Samen geven deze rijen een getal met 2 cijfers weer.

De linkerrij geeft het linker cijfer. De rechterrij het rechter cijfer.

Het cijfer van een rij bepaalt u door afzonderlijke 'LED waardes' op te tellen.

Een knipperende LED telt voor 1 en een brandende LED voor 2.

Een bijzonder geval is 4 knipperende LED's. Dit betekent een 9.

Symbol	Betekenis	LED waarde
○	LED uit	0
☀	LED knippert	1
●	LED brandt	2
☀ ☀ ☀ ☀	Alle LED's van een rij knipperen	9

Voorbeelden instelgetal:

<table style="border-collapse: collapse;"> <tr><td>○</td><td>0</td><td>○</td><td>0</td></tr> <tr><td>○</td><td>0</td><td>●</td><td>2</td></tr> <tr><td>○</td><td>0</td><td>●</td><td>2</td></tr> <tr><td>○</td><td>0</td><td>●</td><td>2</td></tr> <tr><td colspan="2" style="border-top: 1px solid black;">0</td><td colspan="2" style="border-top: 1px solid black;">6</td></tr> </table>	○	0	○	0	○	0	●	2	○	0	●	2	○	0	●	2	0		6		=6
○	0	○	0																		
○	0	●	2																		
○	0	●	2																		
○	0	●	2																		
0		6																			

<table style="border-collapse: collapse;"> <tr><td>○</td><td>0</td><td>☀</td><td>1</td></tr> <tr><td>○</td><td>0</td><td>●</td><td>2</td></tr> <tr><td>●</td><td>2</td><td>●</td><td>2</td></tr> <tr><td>●</td><td>2</td><td>●</td><td>2</td></tr> <tr><td colspan="2" style="border-top: 1px solid black;">4</td><td colspan="2" style="border-top: 1px solid black;">7</td></tr> </table>	○	0	☀	1	○	0	●	2	●	2	●	2	●	2	●	2	4		7		=47
○	0	☀	1																		
○	0	●	2																		
●	2	●	2																		
●	2	●	2																		
4		7																			

<table style="border-collapse: collapse;"> <tr><td>○</td><td>0</td><td>☀</td></tr> <tr><td>○</td><td>0</td><td>☀</td></tr> <tr><td>☀</td><td>1</td><td>☀</td></tr> <tr><td>●</td><td>2</td><td>☀</td></tr> <tr><td colspan="2" style="border-top: 1px solid black;">3</td><td style="border-top: 1px solid black;">9</td></tr> </table>	○	0	☀	○	0	☀	☀	1	☀	●	2	☀	3		9	=39
○	0	☀														
○	0	☀														
☀	1	☀														
●	2	☀														
3		9														

De stapgrootte kan kleiner zijn dan de aflezing. (schaalwaarde) In dat geval moet een druktoets meerdere malen worden ingedrukt voordat de LED aanduiding wijzigt.

2.3.3 Aflezing LED's tweevoudige keuze (Multi/ MultiPlus)

Naast de mogelijkheid om een waarde in te stellen, de meervoudige keuze, is er ook de mogelijkheid van een tweevoudige keuze. Hier kan een bepaalde instelling aan/ uit worden gezet dan wel geactiveerd/ gedeactiveerd worden. Bij een tweevoudige keuze instelling geeft de linker rij mogelijkheid A en de rechter rij mogelijkheid B.

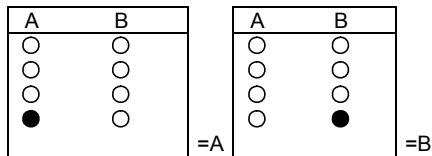

De fabrieksinstelling is altijd A.

Bij de in te stellen waarde is opgegeven waar de A en B voor staan.

2.3.4 Systeemfrequentie (standaard: 50Hz, waarbij de Multi/MultiPlus de frequentie van de AC ingangsspanning zal volgen van 45Hz tot 65Hz, zie onderstaande opmerking)

De Phoenix omvormer and Multi/MultiPlus kunnen ingesteld worden op 50Hz of 60Hz.

Stel de DS 3-7 in	Stel de frequentie in	Voorbeeld										
DS-8 <input type="checkbox"/> DS-7 <input type="checkbox"/> off DS-6 <input type="checkbox"/> off DS-5 <input checked="" type="checkbox"/> on DS-4 <input type="checkbox"/> off DS-3 <input type="checkbox"/> off DS-2 <input type="checkbox"/> DS-1 <input type="checkbox"/>	Bepaal de gewenste frequentie. De fabrieksinstelling is 50Hz. De linker LED rij is voor 50Hz. De rechter LED rij voor 60Hz. Druk op de druktoetsen tot de gewenste LED aanduiding verschijnt.	Gewenst: frequentie is 60Hz. LED aanduiding = <table border="1"> <tr> <td>50Hz</td> <td>60Hz</td> </tr> <tr> <td><input type="radio"/></td> <td><input type="radio"/></td> </tr> <tr> <td><input type="radio"/></td> <td><input type="radio"/></td> </tr> <tr> <td><input type="radio"/></td> <td><input type="radio"/></td> </tr> <tr> <td><input type="radio"/></td> <td><input checked="" type="radio"/></td> </tr> </table>	50Hz	60Hz	<input type="radio"/>	<input type="radio"/>	<input type="radio"/>	<input type="radio"/>	<input type="radio"/>	<input type="radio"/>	<input type="radio"/>	<input checked="" type="radio"/>
50Hz	60Hz											
<input type="radio"/>	<input type="radio"/>											
<input type="radio"/>	<input type="radio"/>											
<input type="radio"/>	<input type="radio"/>											
<input type="radio"/>	<input checked="" type="radio"/>											

Opmerking:

De Phoenix omvormer kan ingesteld worden op 50Hz of 60Hz.

Dit is ook van toepassing op de Multi/MultiPlus, wanneer op de AC ingang geen wisselspanning aanwezig is.

Wanneer echter wel wisselspanning op de AC ingang wordt aangeboden zal de AC uitgang de frequentie van de ingangsspanning volgen van 45Hz tot 65Hz. Dit is om aansluiting op 50Hz zowel als op 60Hz voeding mogelijk te maken.

Met VEConfigure kan het volg gebied beperkt worden tot 45 – 55 Hz of 55 – 65 Hz.

2.3.5 Instelling omvormer

Omvormerspanning (standaard: 230V)

De omvormerspanning kan ingesteld worden van 180Vac-245Vac.

Stel de DS 3-7 in	Stel de spanning in	Voorbeeld																				
DS-8 <input type="checkbox"/> DS-7 <input checked="" type="checkbox"/> on DS-6 <input checked="" type="checkbox"/> on DS-5 <input type="checkbox"/> off DS-4 <input type="checkbox"/> off DS-3 <input type="checkbox"/> off DS-2 <input type="checkbox"/> DS-1 <input type="checkbox"/>	Bepaal de gewenste spanning V_q . Bepaal het instelgetal: $schaal=1V$ $offset=180V$ $instelgetal=(V_q-180)$ Bepaal de LED aanduiding. Druk op de druktoetsen tot de gewenste LED aanduiding verschijnt.	Gewenst: spanning is 225V. Instelgetal = $225-180 = 45$. LED aanduiding = <table border="1" style="margin-left: 20px;"> <tr> <td><input type="checkbox"/></td><td>0</td> <td><input type="checkbox"/></td><td>0</td> </tr> <tr> <td><input type="checkbox"/></td><td>0</td> <td><input checked="" type="checkbox"/></td><td>1</td> </tr> <tr> <td><input checked="" type="checkbox"/></td><td>2</td> <td><input checked="" type="checkbox"/></td><td>2</td> </tr> <tr> <td><input checked="" type="checkbox"/></td><td>2</td> <td><input checked="" type="checkbox"/></td><td>2</td> </tr> <tr> <td colspan="2" style="border-top: 1px solid black;">4</td> <td colspan="2" style="border-top: 1px solid black;">5</td> </tr> </table>	<input type="checkbox"/>	0	<input type="checkbox"/>	0	<input type="checkbox"/>	0	<input checked="" type="checkbox"/>	1	<input checked="" type="checkbox"/>	2	<input checked="" type="checkbox"/>	2	<input checked="" type="checkbox"/>	2	<input checked="" type="checkbox"/>	2	4		5	
<input type="checkbox"/>	0	<input type="checkbox"/>	0																			
<input type="checkbox"/>	0	<input checked="" type="checkbox"/>	1																			
<input checked="" type="checkbox"/>	2	<input checked="" type="checkbox"/>	2																			
<input checked="" type="checkbox"/>	2	<input checked="" type="checkbox"/>	2																			
4		5																				

De stapgrootte is 1V.

LET OP: Voor het instellen van de spanning op de Phoenix inverter moet er gebruik worden gemaakt van een voltmeter, omdat de Phoenix Inverter maar 4 LED's heeft.

2.3.6 Instelling lader (Multi/ MultiPlus)

Tijdens het instellen van de lader dienen alle verbindingen tussen de accu en de Phoenix Multi losgekoppeld worden.

2.3.6.1 Lader aan/ uit (standaard: aan)

De lader van de Phoenix Multi kan desgewenst ook uitgeschakeld worden. De standaard instelling is aan.

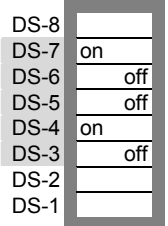
Stel de DS 3-7 in	Schakel de lader aan of uit	Voorbeeld										
 <p>DS-8 DS-7 on DS-6 off DS-5 off DS-4 on DS-3 off DS-2 DS-1</p>	Bepaal of de lader aan of uitgeschakeld moet zijn. De fabrieksinstelling is Aan. De linker LED rij is voor Aan. De rechter LED rij voor Uit. Druk op de druktoetsen tot de gewenste LED aanduiding verschijnt.	Gewenst: lader is uit. LED aanduiding = <table border="1"><tr><td>Aan</td><td>Uit</td></tr><tr><td><input type="radio"/></td><td><input type="radio"/></td></tr><tr><td><input type="radio"/></td><td><input type="radio"/></td></tr><tr><td><input type="radio"/></td><td><input type="radio"/></td></tr><tr><td><input type="radio"/></td><td><input checked="" type="radio"/></td></tr></table>	Aan	Uit	<input type="radio"/>	<input type="radio"/>	<input type="radio"/>	<input type="radio"/>	<input type="radio"/>	<input type="radio"/>	<input type="radio"/>	<input checked="" type="radio"/>
Aan	Uit											
<input type="radio"/>	<input type="radio"/>											
<input type="radio"/>	<input type="radio"/>											
<input type="radio"/>	<input type="radio"/>											
<input type="radio"/>	<input checked="" type="radio"/>											

2.3.6.2 Voorgeprogrammeerde laadkarakteristieken

De Phoenix Multi is voorzien van 3 voorgeprogrammeerde laadkarakteristieken:

De **Fixed laadkarakteristiek** biedt de absorptionspanning voor een bepaalde (vast instelbare) tijd aan. Na de absorptiefase wordt een bepaalde (wederom vast instelbare) tijd de floatspanning aangeboden, om daarna een (meestal kortere) tijd weer de absorptionspanning aan te bieden.

De **Adaptieve laadkarakteristiek** biedt de absorptionspanning aan gedurende een tijd afhankelijk van de lading die tijdens bulk is geleverd. Daarna volgt een floatfase van 24 uur, waarna naar 13/ 26V/ 52V (gereduceerd float) wordt teruggeschakeld. Net als bij de Fixed laadkarakteristiek wordt ook hier periodiek een absorptiefase aangehouden.

Adaptieve laadkarakteristiek met BatterySafe mode (standaard instelling)

Indien, om de laadtijd te verkorten, gekozen wordt voor een hoge laadstroom en ook een verhoogde laadspanning, dan zal de Phoenix Multi Compact / MultiPlus Compact nadat de gasspanning bereikt is de stijgsnelheid van de spanning begrenzen. Zo wordt overmatig gassen voorkomen.

stel de DS 3-7 in	stel de laadkarakteristiek in	voorbeeld																								
DS-8 <input type="checkbox"/> DS-7 <input type="checkbox"/> off DS-6 <input type="checkbox"/> on DS-5 <input type="checkbox"/> on DS-4 <input type="checkbox"/> on DS-3 <input type="checkbox"/> off DS-2 <input type="checkbox"/> DS-1 <input type="checkbox"/>	Bepaal welke laadkarakteristiek gewenst is: 1: Fixed 2: Adaptief 3: Adaptief met accu-beschermingsmodus (default) Druk op de druktoetsen tot de gewenste LED aanduiding verschijnt.	Gewenst: laadkarakteristiek is Fixed. Instelgetal = 1. LED aanduiding = <table border="1" style="margin-left: 20px;"> <tr><td><input type="radio"/></td><td>0</td><td><input type="radio"/></td><td>0</td></tr> <tr><td><input type="radio"/></td><td>0</td><td><input type="radio"/></td><td>0</td></tr> <tr><td><input type="radio"/></td><td>0</td><td><input type="radio"/></td><td>0</td></tr> <tr><td><input type="radio"/></td><td>0</td><td><input checked="" type="radio"/></td><td>1</td></tr> <tr><td colspan="2"><hr/></td><td colspan="2"><hr/></td></tr> <tr><td colspan="2">0</td><td colspan="2">1</td></tr> </table>	<input type="radio"/>	0	<input type="radio"/>	0	<input type="radio"/>	0	<input type="radio"/>	0	<input type="radio"/>	0	<input type="radio"/>	0	<input type="radio"/>	0	<input checked="" type="radio"/>	1	<hr/>		<hr/>		0		1	
<input type="radio"/>	0	<input type="radio"/>	0																							
<input type="radio"/>	0	<input type="radio"/>	0																							
<input type="radio"/>	0	<input type="radio"/>	0																							
<input type="radio"/>	0	<input checked="" type="radio"/>	1																							
<hr/>		<hr/>																								
0		1																								

2.3.6.3 Laadstroom

De laadstroom is standaard ingesteld op 75% van de maximale laadstroom. Voor de meeste toepassingen zal deze stroom te hoog zijn. Om te voorkomen dat de accu's defect raken is het noodzakelijk om de laadstroom aan te passen naar 0,1-0,2x de accucapaciteit.

Stel de DS 3-7 in	Stel de laadstroom in	Voorbeeld																								
DS-8 <input type="checkbox"/> DS-7 <input type="checkbox"/> off DS-6 <input type="checkbox"/> on DS-5 <input type="checkbox"/> off DS-4 <input type="checkbox"/> off DS-3 <input type="checkbox"/> off DS-2 <input type="checkbox"/> DS-1 <input type="checkbox"/>	Bepaal de gewenste laadstroom I_q . Bepaal het instelgetal. $Schaal = 2A$ $Offset = 0A$ $Instelgetal = I_q/2$ Bepaal de LED aanduiding. Druk op de druktoetsen tot de gewenste LED aanduiding verschijnt.	Accucapaciteit is 450Ah. De maximaal geadviseerde laadstroom is $450 \cdot 0,2 = 90A$. Instelgetal = $90/2 = 45$. LED aanduiding = <table border="1" style="margin-left: 20px;"> <tr><td><input type="radio"/></td><td>0</td><td><input type="radio"/></td><td>0</td></tr> <tr><td><input type="radio"/></td><td>0</td><td><input checked="" type="radio"/></td><td>1</td></tr> <tr><td><input checked="" type="radio"/></td><td>2</td><td><input checked="" type="radio"/></td><td>2</td></tr> <tr><td><input checked="" type="radio"/></td><td>2</td><td><input checked="" type="radio"/></td><td>2</td></tr> <tr><td colspan="2"><hr/></td><td colspan="2"><hr/></td></tr> <tr><td colspan="2">4</td><td colspan="2">5</td></tr> </table>	<input type="radio"/>	0	<input type="radio"/>	0	<input type="radio"/>	0	<input checked="" type="radio"/>	1	<input checked="" type="radio"/>	2	<input checked="" type="radio"/>	2	<input checked="" type="radio"/>	2	<input checked="" type="radio"/>	2	<hr/>		<hr/>		4		5	
<input type="radio"/>	0	<input type="radio"/>	0																							
<input type="radio"/>	0	<input checked="" type="radio"/>	1																							
<input checked="" type="radio"/>	2	<input checked="" type="radio"/>	2																							
<input checked="" type="radio"/>	2	<input checked="" type="radio"/>	2																							
<hr/>		<hr/>																								
4		5																								

De stapgrootte is 1A.

2.3.6.4 Voorgeprogrammeerde laadspanningen (standaard: Exide Dryfit)

Om het instellen van de absorption- en floatspanning en maximale absorptietijd te vereenvoudigen is een aantal accutypes voorgedefinieerd:

	Accu type	Absorption spanning			Floatspanning/ Gereduceerde floatspanning			Maximale absorptie tijd
0	Gebruiker bepaald							
1	Exide Dryfit A200 Gel (standaard)	14.4V	28.8V	57.6V	13.8V/ 13.2V	27.6V/ 26.4V	55.2V/ 52.8V	4 uur
2	Tractie (buisjesplaat)	15.0V	30.0V	60.0V	13.8V/ 13.2V	27.6V/ 26.4V	55.2V/ 52.8V	6 uur
3	Semi Tractie ¹ (vlakke plaat)	14.4V	28.8V	57.6V	14.0V/ 13.2V	28.0V/ 26.4V	56.0V/ 52.8V	5 uur
4	Alt. ¹	14.8V	29.6V	59.2V	14.0V/ 13.2V	28.0V/ 26.4V	56.0V/ 52.8V	5 uur

¹De optimale absorptie spanning van vlakke plaat loodzuur accu's hangt af van mechanische en chemische eigenschappen. Accu's met een hoog antimoon gehalte kunnen in het algemeen geladen worden met een lagere absorptie spanning dan accu's met een laag antimoon gehalte. (Zie het boek "Electriciteit aan boord van jachten" op www.victronenergy.com). De lader staat standaard afgeregeld voor het laden van gel accu's zoals de Sonnenschein Dryfit A200 accu. Vraag bij gebruik van andere typen accu's aan uw acculeverancier de juiste laadspanningen en laat zonodig de Phoenix Multi hierop aanpassen. De Laadstroom staat standaard ingesteld op 75% van nominale laadstroom. Vaak is dit een te hoge laadstroom. De meeste accu's dienen geladen te worden met een stroom van 0.1 tot 0.2x de capaciteit.

Stel de DS 3-7 in	Stel het accutype in	Voorbeeld										
DS-8 <input type="checkbox"/> DS-7 <input type="checkbox"/> on DS-6 <input type="checkbox"/> on DS-5 <input type="checkbox"/> off DS-4 <input type="checkbox"/> off DS-3 <input type="checkbox"/> on DS-2 <input type="checkbox"/> DS-1 <input type="checkbox"/>	Bepaal welk accutype gebruikt is. Bepaal het instelgetal aan de hand van de tabel. Druk op de toetsen tot de gewenste LED aanduiding verschijnt. LET OP: 0 kan niet worden gekozen maar zal worden weergegeven als de absorptie-spanning, de floatspanning of de absorptietijd wordt gewijzigd.	Gewenst: accutype is Victory. Instelgetal = 4. LED aanduiding = <table border="1" style="margin-left: 20px;"> <tr> <td><input type="radio"/> 0</td> <td><input type="radio"/> 0</td> </tr> <tr> <td><input type="radio"/> 0</td> <td><input type="radio"/> 0</td> </tr> <tr> <td><input type="radio"/> 0</td> <td><input checked="" type="radio"/> 2</td> </tr> <tr> <td><input type="radio"/> 0</td> <td><input checked="" type="radio"/> 2</td> </tr> <tr> <td>0</td> <td>4</td> </tr> </table>	<input type="radio"/> 0	<input type="radio"/> 0	<input type="radio"/> 0	<input type="radio"/> 0	<input type="radio"/> 0	<input checked="" type="radio"/> 2	<input type="radio"/> 0	<input checked="" type="radio"/> 2	0	4
<input type="radio"/> 0	<input type="radio"/> 0											
<input type="radio"/> 0	<input type="radio"/> 0											
<input type="radio"/> 0	<input checked="" type="radio"/> 2											
<input type="radio"/> 0	<input checked="" type="radio"/> 2											
0	4											

De lader staat standaard afgeregeld voor het laden van gel accu's zoals de Sonnenschein Dryfit A200 accu. Vraag bij gebruik van andere typen accu's aan uw acculeverancier de juiste laadspanningen en laat zonodig de Phoenix Multi hierop aanpassen.

2.3.6.5 Absorptionspanning

De absorptionspanning is in te stellen van 12-16/ 24-32/ 48-64V. Tijdens het instellen moeten accu, de T-sense en V-sense losgekoppeld worden.

Stel de DS 3-7 in	Stel de absorptionspanning in	Voorbeeld																				
DS-8 <input type="text"/> DS-7 <input type="text" value="off"/> DS-6 <input type="text" value="off"/> DS-5 <input type="text" value="off"/> DS-4 <input type="text" value="off"/> DS-3 <input type="text" value="off"/> DS-2 <input type="text"/> DS-1 <input type="text"/>	Bepaal de gewenste absorptionspanning V_q . Bepaal het instelgetal. $Schaal = 0,1V$ $Offset = 12/24V$ $Instelgetal = (V_q - 24)/0,1$ Bepaal de LED aanduiding. Druk op de druktoetsen tot de gewenste LED aanduiding verschijnt.	Gewenst: absorptionspanning is 28,5V. $Instelgetal = (28,5 - 24)/0,1 = 45$. LED aanduiding = <table border="1" style="margin-left: 20px;"> <tr> <td><input type="radio"/></td><td>0</td> <td><input type="radio"/></td><td>0</td> </tr> <tr> <td><input type="radio"/></td><td>0</td> <td><input checked="" type="radio"/></td><td>1</td> </tr> <tr> <td><input checked="" type="radio"/></td><td>2</td> <td><input checked="" type="radio"/></td><td>2</td> </tr> <tr> <td><input checked="" type="radio"/></td><td>2</td> <td><input checked="" type="radio"/></td><td>2</td> </tr> <tr> <td colspan="2" style="border-top: 1px solid black;">4</td> <td colspan="2" style="border-top: 1px solid black;">5</td> </tr> </table>	<input type="radio"/>	0	<input type="radio"/>	0	<input type="radio"/>	0	<input checked="" type="radio"/>	1	<input checked="" type="radio"/>	2	<input checked="" type="radio"/>	2	<input checked="" type="radio"/>	2	<input checked="" type="radio"/>	2	4		5	
<input type="radio"/>	0	<input type="radio"/>	0																			
<input type="radio"/>	0	<input checked="" type="radio"/>	1																			
<input checked="" type="radio"/>	2	<input checked="" type="radio"/>	2																			
<input checked="" type="radio"/>	2	<input checked="" type="radio"/>	2																			
4		5																				

De stapgrootte is 0,05 V.

2.3.6.6 Absorptientijd/ maximale absorptientijd (standaard: 4 uur)

Deze instelling bepaalt bij de fixed laadkarakteristiek hoelang de lader de absorptionspanning aanbiedt. Bij de adaptieve laadkarakteristiek bepaalt deze instelling wat de maximale tijd is dat de lader de absorptionspanning aanbiedt.

De (maximale) absorptientijd kan worden ingesteld van 1 tot 8 uur.

Stel de DS 3-7 in	Stel de (maximale) absorptientijd in	Voorbeeld																				
DS-8 <input type="text"/> DS-7 <input type="text" value="on"/> DS-6 <input type="text" value="off"/> DS-5 <input type="text" value="on"/> DS-4 <input type="text" value="on"/> DS-3 <input type="text" value="off"/> DS-2 <input type="text"/> DS-1 <input type="text"/>	Bepaal de gewenste (maximale) absorptientijd T_q . Bepaal het instelgetal. $Schaal = 1 \text{ uur}$ $Offset = 0$ $Instelgetal = T_q$ Bepaal de LED aanduiding. Druk op de druktoetsen tot de gewenste LED aanduiding verschijnt.	Gewenst: (maximale) absorptientijd is 4 uur. $Instelgetal = 4$. LED aanduiding = <table border="1" style="margin-left: 20px;"> <tr> <td><input type="radio"/></td><td>0</td> <td><input type="radio"/></td><td>0</td> </tr> <tr> <td><input type="radio"/></td><td>0</td> <td><input type="radio"/></td><td>0</td> </tr> <tr> <td><input type="radio"/></td><td>0</td> <td><input checked="" type="radio"/></td><td>2</td> </tr> <tr> <td><input type="radio"/></td><td>0</td> <td><input checked="" type="radio"/></td><td>2</td> </tr> <tr> <td colspan="2" style="border-top: 1px solid black;">0</td> <td colspan="2" style="border-top: 1px solid black;">4</td> </tr> </table>	<input type="radio"/>	0	<input type="radio"/>	0	<input type="radio"/>	0	<input type="radio"/>	0	<input type="radio"/>	0	<input checked="" type="radio"/>	2	<input type="radio"/>	0	<input checked="" type="radio"/>	2	0		4	
<input type="radio"/>	0	<input type="radio"/>	0																			
<input type="radio"/>	0	<input type="radio"/>	0																			
<input type="radio"/>	0	<input checked="" type="radio"/>	2																			
<input type="radio"/>	0	<input checked="" type="radio"/>	2																			
0		4																				

De stapgrootte is 1 uur.

2.3.6.7 Floatspanning

De floatspanning is in te stellen van 12-16/ 24-32/ 48-64V. Tijdens het instellen moeten accu, de T-sense en V-sense losgekoppeld worden.

Stel de DS 3-7 in	Stel de floatspanning in	Voorbeeld																				
DS-8 <input type="text"/> DS-7 <input type="text"/> on DS-6 <input type="text"/> off DS-5 <input type="text"/> off DS-4 <input type="text"/> off DS-3 <input type="text"/> off DS-2 <input type="text"/> DS-1 <input type="text"/>	Bepaal de gewenste floatspanning V_q . Bepaal het instelgetal. $Schaal = 0,1V$ $Minimum = 12/24V$ $Instelgetal = (V_q - 24)/0,1$ Bepaal de LED aanduiding. Druk op de druktoetsen tot de gewenste LED aanduiding verschijnt.	Gewenst: floatspanning is 28,5V. $Instelgetal = (28,5 - 24)/0,1 = 45$. LED aanduiding = <table border="1" style="margin-left: 20px;"> <tr> <td><input type="radio"/></td><td>0</td><td><input type="radio"/></td><td>0</td> </tr> <tr> <td><input type="radio"/></td><td>0</td><td><input checked="" type="radio"/></td><td>1</td> </tr> <tr> <td><input checked="" type="radio"/></td><td>2</td><td><input checked="" type="radio"/></td><td>2</td> </tr> <tr> <td><input checked="" type="radio"/></td><td>2</td><td><input checked="" type="radio"/></td><td>2</td> </tr> <tr> <td colspan="2" style="border-top: 1px solid black;">4</td> <td colspan="2" style="border-top: 1px solid black;">5</td> </tr> </table>	<input type="radio"/>	0	<input type="radio"/>	0	<input type="radio"/>	0	<input checked="" type="radio"/>	1	<input checked="" type="radio"/>	2	<input checked="" type="radio"/>	2	<input checked="" type="radio"/>	2	<input checked="" type="radio"/>	2	4		5	
<input type="radio"/>	0	<input type="radio"/>	0																			
<input type="radio"/>	0	<input checked="" type="radio"/>	1																			
<input checked="" type="radio"/>	2	<input checked="" type="radio"/>	2																			
<input checked="" type="radio"/>	2	<input checked="" type="radio"/>	2																			
4		5																				

De stapgrootte is 0,05 V.

2.3.6.8 Herhaald absorption

Na iedere laadcyclus zal de lader na de floatfase na een ingestelde tijd terugschakelen naar de hoge laadspanning. Dit terugschakelen heet de 'herhaald absorptionfase', zie appendix C.

Herhaald absorptietijd (standaard: 1 uur)



De herhaald absorptietijd kan worden ingesteld van 1 tot 72 kwartier.

Stel de DS 3-7 in	Stel de herhaald absorptietijd in	Voorbeeld																				
DS-8 <input type="text"/> DS-7 <input type="text"/> on DS-6 <input type="text"/> on DS-5 <input type="text"/> on DS-4 <input type="text"/> off DS-3 <input type="text"/> off DS-2 <input type="text"/> DS-1 <input type="text"/>	Bepaal de gewenste Herhaald absorptietijd T_q in kwartieren. Bepaal het instelgetal. $Schaal = 1 \text{ kwartier}$ $Offset = 0$ $Instelgetal = T_q$ Bepaal de LED aanduiding. Druk op de druktoetsen tot de gewenste LED aanduiding verschijnt.	Gewenst: Herhaald absorptietijd is 1 uur. $Instelgetal = 1 \text{ uur} = 4 \text{ kwartier}$ LED aanduiding = <table border="1" style="margin-left: 20px;"> <tr> <td><input type="radio"/></td><td>0</td><td><input type="radio"/></td><td>0</td> </tr> <tr> <td><input type="radio"/></td><td>0</td><td><input type="radio"/></td><td>0</td> </tr> <tr> <td><input type="radio"/></td><td>0</td><td><input checked="" type="radio"/></td><td>2</td> </tr> <tr> <td><input type="radio"/></td><td>0</td><td><input checked="" type="radio"/></td><td>2</td> </tr> <tr> <td colspan="2" style="border-top: 1px solid black;">0</td> <td colspan="2" style="border-top: 1px solid black;">4</td> </tr> </table>	<input type="radio"/>	0	<input type="radio"/>	0	<input type="radio"/>	0	<input type="radio"/>	0	<input type="radio"/>	0	<input checked="" type="radio"/>	2	<input type="radio"/>	0	<input checked="" type="radio"/>	2	0		4	
<input type="radio"/>	0	<input type="radio"/>	0																			
<input type="radio"/>	0	<input type="radio"/>	0																			
<input type="radio"/>	0	<input checked="" type="radio"/>	2																			
<input type="radio"/>	0	<input checked="" type="radio"/>	2																			
0		4																				

De stapgrootte is 1 kwartier.

Herhaald absorptieinterval (standaard: 7 dagen)

Het herhaald absorptieinterval, ook wel reduced float genoemd, kan worden ingesteld van 1 tot 45 dagen.

Stel de DS 3-7 in	Stel de herhaald absorptieinterval (reduced float) in	Voorbeeld																				
DS-8 <input type="text"/> DS-7 <input type="text" value="off"/> DS-6 <input type="text" value="off"/> DS-5 <input type="text" value="off"/> DS-4 <input type="text" value="on"/> DS-3 <input type="text" value="off"/> DS-2 <input type="text"/> DS-1 <input type="text"/>	Bepaal de gewenste reduced floattijd T_q . Bepaal het instelgetal. $Schaal = 1 \text{ dag}$ $Offset = 0$ $Instelgetal = T_q$ Bepaal de LED aanduiding. Druk op de druktoetsen tot de gewenste LED aanduiding verschijnt.	Gewenst: reduced floattijd is 1 week. Instelgetal = 7. LED aanduiding = <table border="1" style="margin-left: 20px;"> <tr> <td><input type="radio"/></td> <td>0</td> <td></td> <td>1</td> </tr> <tr> <td><input type="radio"/></td> <td>0</td> <td><input checked="" type="radio"/></td> <td>2</td> </tr> <tr> <td><input type="radio"/></td> <td>0</td> <td><input checked="" type="radio"/></td> <td>2</td> </tr> <tr> <td><input type="radio"/></td> <td>0</td> <td><input checked="" type="radio"/></td> <td>2</td> </tr> <tr> <td colspan="3" style="border-top: 1px solid black; border-bottom: 1px solid black; text-align: center;">0</td> <td style="border-top: 1px solid black; border-bottom: 1px solid black; text-align: center;">7</td> </tr> </table>	<input type="radio"/>	0		1	<input type="radio"/>	0	<input checked="" type="radio"/>	2	<input type="radio"/>	0	<input checked="" type="radio"/>	2	<input type="radio"/>	0	<input checked="" type="radio"/>	2	0			7
<input type="radio"/>	0		1																			
<input type="radio"/>	0	<input checked="" type="radio"/>	2																			
<input type="radio"/>	0	<input checked="" type="radio"/>	2																			
<input type="radio"/>	0	<input checked="" type="radio"/>	2																			
0			7																			

De stapgrootte is 1 dag.

2.3.7 Bijzondere instellingen

2.3.7.1 Bulkbescherming aan/ uit (standaard: aan)

Als de lader na 10 uur in de bulkfase te hebben geladen de absorption spanning nog niet heeft bereikt kan het zijn dat de accu defect is. Om verdere schade te voorkomen zal de lader na 10 uur bulk automatisch worden uitgeschakeld. De "bulk" LED gaat dan knipperen. Deze beveiliging is uit te schakelen.

stel de DS 3-7 in	stel de bulkbescherming aan of uit	voorbeeld										
DS-8 <input type="checkbox"/> DS-7 <input type="checkbox"/> off DS-6 <input type="checkbox"/> on DS-5 <input type="checkbox"/> off DS-4 <input type="checkbox"/> on DS-3 <input type="checkbox"/> off DS-2 <input type="checkbox"/> DS-1 <input type="checkbox"/>	Bepaal of bulkbescherming aan of uit moet zijn. De fabrieksinstelling is Aan. De linker LED rij is voor Aan. De rechter LED rij voor Uit. Druk op de druktoetsen tot de gewenste LED aanduiding verschijnt.	Gewenst: bulkbescherming is uit. LED aanduiding = <table border="1" style="margin-left: 20px;"> <tr> <td>Aan</td> <td>Uit</td> </tr> <tr> <td><input type="checkbox"/></td> <td><input type="checkbox"/></td> </tr> <tr> <td><input type="checkbox"/></td> <td><input type="checkbox"/></td> </tr> <tr> <td><input type="checkbox"/></td> <td><input type="checkbox"/></td> </tr> <tr> <td><input type="checkbox"/></td> <td><input checked="" type="checkbox"/></td> </tr> </table>	Aan	Uit	<input type="checkbox"/>	<input type="checkbox"/>	<input type="checkbox"/>	<input type="checkbox"/>	<input type="checkbox"/>	<input type="checkbox"/>	<input type="checkbox"/>	<input checked="" type="checkbox"/>
Aan	Uit											
<input type="checkbox"/>	<input type="checkbox"/>											
<input type="checkbox"/>	<input type="checkbox"/>											
<input type="checkbox"/>	<input type="checkbox"/>											
<input type="checkbox"/>	<input checked="" type="checkbox"/>											

2.3.7.2 Sinus Check (standaard: aan)

De Phoenix Multi controleert of de AC ingangsspanning niet alleen de juiste voltage heeft, maar ook de juiste sinus vorm. **Als de Phoenix Multi niet juist functioneert op een generator kan deze functie worden uitgeschakeld.**

Setup van DS 3-7	Schakel de netspanning check op on of op off	Voorbeeld										
DS-8 <input type="checkbox"/> DS-7 <input type="checkbox"/> off DS-6 <input type="checkbox"/> on DS-5 <input type="checkbox"/> off DS-4 <input type="checkbox"/> off DS-3 <input type="checkbox"/> on DS-2 <input type="checkbox"/> DS-1 <input type="checkbox"/>	Bepaal of de netspanning op On of op Off moet worden geschakeld. De fabrieksinstelling is On. De linkerkolom LED's is voor On. De rechterkolom LED's is voor Off. Druk op de knop tot dat de benodigde LED indicatie wordt weergegeven.	Benodigd: Net Sinus vorm Check is off. LED indicatie = <table border="1" style="margin-left: 20px;"> <tr> <td>On</td> <td>Off</td> </tr> <tr> <td><input type="checkbox"/></td> <td><input type="checkbox"/></td> </tr> <tr> <td><input type="checkbox"/></td> <td><input type="checkbox"/></td> </tr> <tr> <td><input type="checkbox"/></td> <td><input type="checkbox"/></td> </tr> <tr> <td><input type="checkbox"/></td> <td><input checked="" type="checkbox"/></td> </tr> </table>	On	Off	<input type="checkbox"/>	<input type="checkbox"/>	<input type="checkbox"/>	<input type="checkbox"/>	<input type="checkbox"/>	<input type="checkbox"/>	<input type="checkbox"/>	<input checked="" type="checkbox"/>
On	Off											
<input type="checkbox"/>	<input type="checkbox"/>											
<input type="checkbox"/>	<input type="checkbox"/>											
<input type="checkbox"/>	<input type="checkbox"/>											
<input type="checkbox"/>	<input checked="" type="checkbox"/>											

GB

NL

F

D

Appendix

2.3.7.3 PowerControl : omgaan met beperkte generator/ walstroom

Ter bescherming van de generator of van de walstroomaansluiting wordt de laadstroom zodanig ingesteld dat de gezamenlijk afgenomen stroom door de lader en de AC verbruikers niet boven de ingestelde stroom komt.

Als het AC verbruik boven de ingestelde stroom komt, zal de lader uitschakelen en de "mains on" LED gaan knipperen. Het is nu mogelijk dat de walzekering doorslaat of de generator door overbelasting uitschakelt. In dat geval zal de Multi proberen om te schakelen naar omvormerbedrijf.

De generator/ walstroom kan worden ingesteld van 2 tot 16A (optioneel: 4 tot 30A) .

Stel de DS 3-7 in	Stel de walstroom in	Voorbeeld																				
DS-8 <input type="text"/> DS-7 <input type="text" value="off"/> DS-6 <input type="text" value="on"/> DS-5 <input type="text" value="on"/> DS-4 <input type="text" value="off"/> DS-3 <input type="text" value="off"/> DS-2 <input type="text"/> DS-1 <input type="text"/>	Bepaal de gewenste walstroombegrenzing Iq. Bepaal het instelgetal. $Schaal = 1A$ $Offset = 0$ $Instelgetal = (Iq)/1$ Bepaal de LED aanduiding. Druk op de druktoetsen tot de gewenste LED aanduiding verschijnt.	Gewenst: walstroombegrenzing is 16A. Instelgetal = 16. LED aanduiding = <table border="1" style="margin-left: 20px;"> <tr> <td><input type="radio"/></td> <td>0</td> <td><input type="radio"/></td> <td>0</td> </tr> <tr> <td><input type="radio"/></td> <td>0</td> <td><input checked="" type="radio"/></td> <td>2</td> </tr> <tr> <td><input type="radio"/></td> <td>0</td> <td><input checked="" type="radio"/></td> <td>2</td> </tr> <tr> <td><input checked="" type="radio"/></td> <td>1</td> <td><input checked="" type="radio"/></td> <td>2</td> </tr> <tr> <td></td> <td><u>1</u></td> <td></td> <td><u>6</u></td> </tr> </table>	<input type="radio"/>	0	<input type="radio"/>	0	<input type="radio"/>	0	<input checked="" type="radio"/>	2	<input type="radio"/>	0	<input checked="" type="radio"/>	2	<input checked="" type="radio"/>	1	<input checked="" type="radio"/>	2		<u>1</u>		<u>6</u>
<input type="radio"/>	0	<input type="radio"/>	0																			
<input type="radio"/>	0	<input checked="" type="radio"/>	2																			
<input type="radio"/>	0	<input checked="" type="radio"/>	2																			
<input checked="" type="radio"/>	1	<input checked="" type="radio"/>	2																			
	<u>1</u>		<u>6</u>																			

De stapgrootte is 1A.

Bij gebruik van het afstandsbedieningspaneel wordt de walstroom instelling bepaald door het afstandsbedieningspaneel.

Wanneer de aan de Phoenix Multi aangeboden spanningsvorm niet zuiver sinusvorming is, bestaat de kans dat de Phoenix Multi deze niet zal accepteren. U kunt deze detectie uitschakelen. De dan aangeboden spanning zal direct doorgeschakeld worden naar de verbruikers. De omschakeltijd zal nu langer dan 20 msec bedragen.

2.3.7.4 PowerAssist – Doe meer met uw aggregaat of walstroom: de unieke “meehelp” functie van de MultiPlus (standaard: aan)

Met de MultiPlus kunt U nog een stap verder gaan. De MultiPlus werkt parallel met het aggregaat of de walaansluiting en verdubbelt het beschikbare vermogen. Tijdelijk te weinig stroom? De MultiPlus haalt extra energie uit de accu en helpt mee! Nog stroom over? De MultiPlus maakt er gebruik van om de accu te laden. U stelt de walstroom in met een simpele 0 tot 16 A draaiknop op het Phoenix Multi Control paneel.

Noot 1: Voor de goede werking van PowerAssist dient minstens 2A netvoeding of 2.5 kW aggregaatvermogen beschikbaar te zijn per MultiPlus.

Noot 2: Sommige moderne generatoren generen de wisselstroom m. b. v. een statische omvormer. Het toerental van deze generatoren wordt meestal teruggeregeld bij geringe belasting. Indien met VEConfigure de “**Dynamic Current Limit**”functie aangezet wordt zal de MultiPlus een plotselinge belastingsprong opvangen totdat de motor van het aggregaat weer op volle toeren draait.

Stel de DS 3-7 in	Zet PowerAssist aan of uit	Voorbeeld										
DS-8 <input type="checkbox"/> DS-7 <input type="checkbox"/> on DS-6 <input type="checkbox"/> off DS-5 <input type="checkbox"/> on DS-4 <input type="checkbox"/> off DS-3 <input type="checkbox"/> off DS-2 <input type="checkbox"/> DS-1 <input type="checkbox"/>	Bepaal of PowerAssist aan of uit moet zijn. De fabrieksinstelling is Uit. De linker LED rij is voor Uit. De rechter LED rij voor Aan. Druk op de druktoetsen tot de gewenste LED aanduiding verschijnt.	Gewenst: PowerAssist is aan. LED aanduiding = <table border="1" style="margin-left: 20px;"> <thead> <tr> <th>Uit</th> <th>Aan</th> </tr> </thead> <tbody> <tr> <td><input type="checkbox"/></td> <td><input type="checkbox"/></td> </tr> <tr> <td><input type="checkbox"/></td> <td><input type="checkbox"/></td> </tr> <tr> <td><input type="checkbox"/></td> <td><input type="checkbox"/></td> </tr> <tr> <td><input type="checkbox"/></td> <td><input checked="" type="checkbox"/></td> </tr> </tbody> </table>	Uit	Aan	<input type="checkbox"/>	<input type="checkbox"/>	<input type="checkbox"/>	<input type="checkbox"/>	<input type="checkbox"/>	<input type="checkbox"/>	<input type="checkbox"/>	<input checked="" type="checkbox"/>
Uit	Aan											
<input type="checkbox"/>	<input type="checkbox"/>											
<input type="checkbox"/>	<input type="checkbox"/>											
<input type="checkbox"/>	<input type="checkbox"/>											
<input type="checkbox"/>	<input checked="" type="checkbox"/>											

GB

NL

F

D

Appendix

2.3.7.5 3-fase instelling (standaard: uit)

Voor het maken van een 3-fase net moeten drie Phoenix MultiPlus apparaten, van hetzelfde type, met elkaar verbonden worden volgens appendix 0. De accu's moeten aangesloten worden volgens appendix E of F. Hierna moeten er nog een aantal instellingen per apparaat worden gemaakt.

Eerst moeten alle apparaten ingesteld worden voor 3-fase werking.

Stel de DS 3-7 in	Schakel 3-fase bedrijf aan of uit	Voorbeeld										
DS-8 <input type="checkbox"/> DS-7 <input type="checkbox"/> on DS-6 <input type="checkbox"/> on DS-5 <input type="checkbox"/> off DS-4 <input type="checkbox"/> on DS-3 <input type="checkbox"/> off DS-2 <input type="checkbox"/> DS-1 <input type="checkbox"/>	Bepaal of 3-fase bedrijf aan of uit moet zijn. De fabrieksinstelling is Uit. De linker LED rij is voor Uit. De rechter LED rij voor Aan. Druk op de druktoetsen tot de gewenste LED aanduiding verschijnt.	Gewenst: 3-fase bedrijf is aan. LED aanduiding = <table border="1" style="margin-left: 20px;"> <thead> <tr> <th>Uit</th> <th>Aan</th> </tr> </thead> <tbody> <tr> <td><input type="checkbox"/></td> <td><input type="checkbox"/></td> </tr> <tr> <td><input type="checkbox"/></td> <td><input type="checkbox"/></td> </tr> <tr> <td><input type="checkbox"/></td> <td><input type="checkbox"/></td> </tr> <tr> <td><input type="checkbox"/></td> <td><input checked="" type="checkbox"/></td> </tr> </tbody> </table>	Uit	Aan	<input type="checkbox"/>	<input type="checkbox"/>	<input type="checkbox"/>	<input type="checkbox"/>	<input type="checkbox"/>	<input type="checkbox"/>	<input type="checkbox"/>	<input checked="" type="checkbox"/>
Uit	Aan											
<input type="checkbox"/>	<input type="checkbox"/>											
<input type="checkbox"/>	<input type="checkbox"/>											
<input type="checkbox"/>	<input type="checkbox"/>											
<input type="checkbox"/>	<input checked="" type="checkbox"/>											

Na deze instelling moet één van de drie apparaten als "master" ingesteld worden. We noemen dit bij 3-fasebedrijf "Leader". De andere apparaten hoeven geen andere instelling.

Stel de DS 3-7 in	Stel Leader/ Follower in	Voorbeeld										
DS-8 <input type="checkbox"/> DS-7 <input type="checkbox"/> off DS-6 <input type="checkbox"/> off DS-5 <input type="checkbox"/> on DS-4 <input type="checkbox"/> on DS-3 <input type="checkbox"/> off DS-2 <input type="checkbox"/> DS-1 <input type="checkbox"/>	Bepaal Leader of Follower. De fabrieksinstelling is Follower. De linker LED rij is voor Follower. De rechter LED rij voor Leader. Druk op de druktoetsen tot de gewenste LED aanduiding verschijnt.	Gewenst: dit apparaat is Leader. LED aanduiding = <table border="1" style="margin-left: 20px;"> <thead> <tr> <th>Follower</th> <th>Leader</th> </tr> </thead> <tbody> <tr> <td><input type="checkbox"/></td> <td><input type="checkbox"/></td> </tr> <tr> <td><input type="checkbox"/></td> <td><input type="checkbox"/></td> </tr> <tr> <td><input type="checkbox"/></td> <td><input type="checkbox"/></td> </tr> <tr> <td><input type="checkbox"/></td> <td><input checked="" type="checkbox"/></td> </tr> </tbody> </table>	Follower	Leader	<input type="checkbox"/>	<input type="checkbox"/>	<input type="checkbox"/>	<input type="checkbox"/>	<input type="checkbox"/>	<input type="checkbox"/>	<input type="checkbox"/>	<input checked="" type="checkbox"/>
Follower	Leader											
<input type="checkbox"/>	<input type="checkbox"/>											
<input type="checkbox"/>	<input type="checkbox"/>											
<input type="checkbox"/>	<input type="checkbox"/>											
<input type="checkbox"/>	<input checked="" type="checkbox"/>											

2.4 Instellingen wijzigen met VEConfigure software

Alle instellingen kunnen gewijzigd worden met VEConfigure software

U kunt de VEConfigure software downloaden van www.victronenergy.com

De volgende instellingen kunnen uitsluitend met VEConfigure gewijzigd worden:

- **Ground relay (alleen Multi/MultiPlus, standaard: on).** When running on inverter the output neutral is connected to the output ground wire and therefore also the chassis. This is to ensure proper functioning of a GFCI (Ground Fault Circuit Interrupter), to be installed on the AC output of the MultiPlus. In an isolated system the ground relay should be disabled. Proper isolation of both phase and neutral from ground should then be monitored with an isolation watch system.

- **Dynamic current limit (default: off).** Some modern AC generators use a static inverter to generate the AC output. Some of these generators also reduce rpm when operating with reduced load. By enabling the Dynamic Current Limit function (VEConfigure) the MultiPlus can be used to assist the generator when suddenly a high load is connected.

- **Alarm Relay / Virtual Switch (default: disabled)**

A programmable relay is available in both the Phoenix Inverter and Multi/MultiPlus. This relay can be used for remote alarm and other purposes (a. o. generator start signal). The relay can be programmed with VEConfigure.

- **Frequentie van de AC ingang:** zie paragraaf 2.3.4.

2.5 Onderhoud

De Phoenix Multi vereist geen specifiek onderhoud. Het volstaat alle verbindingen eenmaal per jaar te controleren. Voorkom dat de Phoenix Multi vocht en olie/roet dampen en houd het apparaat schoon.

GB

NL

F

D

Appendix

3. FOUTZOEKSCHEMA

Met behulp van onderstaande stappen kunnen de meest voorkomende storingen snel worden opgespoord.

Voordat testen met de omvormer en/ of acculader worden uitgevoerd dienen de DC-belastingen te worden losgekoppeld van de accu's en de AC-apparatuur dient te worden losgekoppeld van de omvormer.

Indien de fout niet opgelost kan worden, raadpleeg uw Victron Energy distributeur.

Probleem	Oorzaak	Oplossing
De omvormer werkt niet wanneer deze wordt ingeschakeld.	De accuspanning is te hoog of te laag.	Zorg dat de accuspanning binnen de juiste waarde is.
De LED "low battery" knippert.	De accuspanning is laag.	Laad de accu op of controleer de accu aansluitingen.
De LED "low battery" brandt.	De omvormer schakelt uit, omdat de accuspanning te laag is.	Laad de accu op of controleer de accu aansluitingen.
De LED "overload" knippert.	De belasting op de omvormer is hoger dan de nominale belasting.	Ontkoppel een deel van de belasting.
De LED "overload" brandt.	De omvormer is uitgeschakeld als gevolg van een te hoge belasting.	Ontkoppel een deel van de belasting.
De LED "temperature" knippert of brandt.	De omgevingstemperatuur is hoog, of de belasting is te hoog.	Plaats de omvormer in een koele en goed geventileerde omgeving of ontkoppel een deel van de belasting.
De LED's "low battery" en "overload" knipperen afwisselend.	Lage accuspanning en te hoge belasting.	Laad de accu's op, ontkoppel een deel van de belasting of plaats accu's met een hogere capaciteit. Monteer kortere en/ of dikkere accukabels. Controleer de dynamo.
De LED's "low battery" en "overload" knipperen tegelijk.	Rimpelspanning op de DC-aansluiting overschrijdt 1,25Vrms.	Controleer de accukabels en accuaansluitingen. Wees er zeker van dat de accucapaciteit voldoende is, verhoog deze eventueel.
De LED's "low battery" en "overload" branden.	De omvormer is uitgeschakeld als gevolg van een te hoge rimpelspanning op de ingang.	Plaats accu's met een hogere capaciteit. Monteer kortere en/ of dikkere accukabels en reset de omvormer (uit- en weer inschakelen)

Probleem	Oorzaak	Oplossing
Een alarm LED brandt en de tweede knippert	De omvormer is uitgeschakeld als gevolg van de alarmering van de brandende LED. De knipperende LED geeft aan dat de omvormer bijna uitgeschakeld is als gevolg van het betreffende alarm.	Controleer deze tabel om acties te nemen overeenkomstig het alarm.
De lader werkt niet	De netspanning of –frequentie is buiten het bereik.	Zorg dat de netspanning tussen 185 Vac en 265 Vac komt te liggen en dat de frequentie overeenkomt met de instelling.
	De thermische onderbreker is geactiveerd.	Reset de 16 A thermische onderbreker.
De accu wordt niet volledig opgeladen.	Verkeerde laadstroom.	Stel de laadstroom in tussen 0,1 en 0,2x de accucapaciteit.
	Een slechte accuaansluiting.	Controleer de accuaansluitingen.
	De absorptionspanning is op een verkeerde waarde ingesteld.	Regel de absorptionspanning af op een goede waarde.
	De floatspanning is op een verkeerde waarde ingesteld.	Regel de floatspanning af op een goede waarde.
	De capaciteit van de accu is te groot.	Sluit een accu aan met een kleinere capaciteit en verhoog de laadstroominstelling.
	De uitgangszekering is kapot.	Vervang de uitgangszekering.
De accu wordt overladen.	De absorptionspanning is op een verkeerde waarde ingesteld.	Regel de absorptionspanning af op een goede waarde.
	De floatspanning is op een verkeerde waarde ingesteld.	Regel de floatspanning af op een goede waarde.
	Een slechte accu.	Vervang de accu.
	Een te kleine accu.	Reduceer de laadstroom of gebruik een accu met een hogere capaciteit.
	De accu staat te warm.	Sluit een temperatuursensor aan.

GB

NL

F

D

Appendix

De laadstroom zakt terug naar 0 zodra de absorptie fase ingaat	De accu is oververhit (>50°C)	<ul style="list-style-type: none"> - Plaats de accu in een koelere ruimte - Verlaag de laadstroom - Kijk of een van de accucellen een interne sluiting heeft
	De accu temperatuur sensor is stuk	<p>Maak het stekkertje van de temperatuur sensor in de Multi los.</p> <p>Reset de Multi door deze uit te schakelen en na minstens 4 seconden wachten weer aan te zetten.</p> <p>Indien de laad functie nu weer goed is moet de temperatuur sensor vervangen worden.</p>

4. TECHNISCHE SPECIFICATIES

Phoenix Multi/MultiPlus	12/2000/100	12/3000/120	24/2000/60	24/3000/70	48/3000/35
OMVORMER					
Ingangsspanningsbereik (V DC)	9,5-16,1	9,5-16,1	19,0-32,2	19,0-32,2	38,0-64,4
Uitgangsspanning (V AC)	230 ± 2%				
Frequentie (Hz) (1)	50 ± 0,1%				
Continu vermogen bij 25 °C (VA) (5)	2000	3000	2000	3000	3000
Continu vermogen bij 25 °C (W)	1800	2500	1800	2500	2500
Continu vermogen bij 40 °C (W)	1400	1600	1500	2000	2000
Piek vermogen (W)	4000	4500	4000	6000	6000
Maximaal rendement (%)	93	93	94	94	95
Nullast (W)	6	6	6	6	10
LADER					
Ingangsspanningsbereik (V AC)	187-265				
Ingangsfrequentie (Hz)	45 - 55				
Powerfactor	1				
Laadspanning 'absorption' (V DC)	14,4	14,4	28,8	28,8	57,6
Laadspanning 'float' (V DC)	13,8	13,8	27,6	27,6	55,2
Laadspanning 'opslag' (V DC)	13,2	13,2	26,4	26,4	52,8
Laadstroom accessoire accu (A) (4)	100	120	60	70	35
Laadstroom startaccu (A)	4	4	4	4	4
Accucapaciteit (Ah)	300-1000	400-1200	150-600	200-700	100-400
Temperatuur sensor	√	√	√	√	√

GB

NL

F

D

Appendix

Phoenix Multi/MultiPlus	12/2000/100	12/3000/120	24/2000/60	24/3000/70	48/3000/35
ALGEMEEN					
Multipurpose relais	√ (6)				
Geforceerde koeling	√				
Beveiligingen (2)	a - h				
Temperatuur bereik	-20 tot +50°C				
Vocht (niet condenserend)	max 95%				
BEHUIZING					
Materiaal & kleur	aluminium (blauw RAL 5012)				
Accu-aansluiting	M8 bouten				
230 V AC-aansluiting	schroefklem 2,5 mm ²				
Beschermklasse	IP 21				
Gewicht (kg)	18	18	18	18	18
Afmetingen (hxbxd in mm)	362x258x218				
NORMEN					
Veiligheid	EN 60335-1, EN 60335-2-29				
Emissie	EN 50081-1, EN55014, EN 61000-3-2, EN 61000-3-3				
Immunititeit	EN 55014-2				
Automotive Directive	95/54/EC				n. a.

1) Iedere Phoenix Multi/MultiPlus kan worden ingesteld op 60 Hz

2) Beveiligingen

a. Kortsluiting

b. Overbelasting

c. Accuspanning te hoog

d. Accuspanning te laag

e. Accu-ompooldetectie

f. Wisselspanning op de uitgang

g. Ingangsspanning met een te hoge rimpel

h. Temperatuur te hoog

3) Niet verkrijgbaar in MultiPlus versie

4) Bij 25°C omgevingstemperatuur

5) Niet lineaire belasting, crest faktor 3:1

6) Relais instelbaar als algemeen alarm relais, onderspanning alarm of start relais voor een aggregaat.

1. INSTALLATION



Le Phoenix Multi doit être installé par un technicien qualifié.

GB

NL

F

D

Appendix

1.1 Contenu de l'emballage

L'emballage du Phoenix Multi contient les articles suivants :

- Phoenix Multi.
- Manuel d'utilisation.
- Manuel d'installation.
- Sachet de matériel de connexion comprenant :
 - Sonde de température.
 - Fusible. (Mega fuse)
 - Quatre écrous M8.
 - Quatre rondelles M8.
 - Quatre rondelles à ressort M8.
 - Autocollant d'avertissement 'Courant de charge'.

1.2 Emplacement

Le Phoenix Multi doit être installé dans un endroit sec et bien ventilé au plus près des batteries. Ménagez autour de l'appareil un espace minimum de 50mm pour le refroidissement.



Une température ambiante trop élevée aura pour conséquences :

- Moindre durée de vie.
- Courant de charge réduit.
- Une puissance de pointe moindre ou un arrêt total du convertisseur.

Ne jamais placer l'appareil directement au-dessus des batteries.

Le Phoenix Multi est prévu pour montage mural. Pour ce montage, des trous ont été ménagés à l'arrière du boîtier, voir appendice B.

L'appareil peut être monté horizontalement ou verticalement, mais le montage vertical est préférable. Le refroidissement est meilleur dans cette position.



L'intérieur de l'appareil doit être bien accessible même après installation.

Assurez-vous que les câbles de branchement soient équipés de fusibles et disjoncteur. Maintenir la distance entre le Phoenix Multi et les batteries aussi courte que possible afin de réduire la perte de tension dans les câbles.



Pour tout appareil où il est question de convertir une forte puissance électrique, il est de règle de le placer en prévention dans un endroit résistant à la chaleur. Evitez pour cette raison de placer l'appareil à proximité de tous produits chimiques, objets en matière plastique, rideaux et autres pièces d'ameublement pouvant être sensibles à la chaleur.

1.3 Outillage nécessaire

- Un tournevis cruciforme (PH 2) pour retirer la face-avant.
- Un tournevis plat (0,6x3,5) pour le raccordement des câbles AC.
- Une clef à pipe isolée (13 mm) pour le serrage des écrous de raccordement et du fusible.
- Deux câbles de batteries (longueur maximum 6 mètres) avec cosses.
- Câble à 3 conducteurs.

1.4 Raccordement des câbles de batterie

Pour employer au maximum la capacité du Phoenix Multi, il est important d'utiliser des batteries d'une capacité suffisante et des câbles adaptés à la puissance. Voir tableau.

	12/2000/100	12/3000/120	24/2000/60	24/3000/70	48/3000/35
Capacité de batterie recommandée (Ah)	300–1000	400–1200	150–600	200–700	100–400
Section de câble recommandée (mm ²) (0 – 6 m)					
0 – 5 m	70	90	40	50	35
5 – 10 m	100	120	70	90	70

Procédure

Pour le raccordement des câbles de batterie, procéder comme suit :



Pour prévenir tout danger de court-circuit, utiliser exclusivement une clef à pipe isolée.

Eviter le court-circuit des câbles de batterie.

- Dévisser les quatre vis sur l'avant du capot et enlever la face-avant.
- Connecter les câbles : Le + (rouge) à droite et le - (noir) à gauche, voir appendice A.
- Si les câbles de batterie du Phoenix Multi sont inversés (+ sur – et – sur +), la LED "reversed polarity" près des écrous de raccordement s'allume, pour indiquer l'inversion de la polarité.
- Si la LED "reversed polarity" s'allume, déconnecter les câbles et les raccorder correctement.
- Serrer le raccord après la mise en place de la visserie fournie.
- Placer le 'mega fuse' fourni en position F4 et serrer le raccord après la mise en place de la visserie fournie.
- Serrer les écrous fermement pour réduire au mieux la résistance de raccordement.

1.5 Connexion des câbles AC



Pour des raisons de sécurité, le boîtier du Phoenix Multi doit être relié à la terre. La borne de terre se trouve sur le dessous du boîtier.

Le bloc de connexion se trouve sur le circuit imprimé, voir appendice A. L'alimentation secteur ou quai doit être raccordée sur le Multi à l'aide d'un câble à trois conducteurs. Utiliser un câble 3 conducteurs souples de section 2,5 ou 4 mm² (type H05RN-F).

Procédure

Pour le raccordement des câbles AC, procéder comme suit :

- La sortie AC peut être raccordée directement sur le bloc de connexion portant le texte "AC-out" au moyen d'un câble à 3 conducteurs. Les plots de connexion sont clairement identifiés. De gauche à droite : "PE" (terre), "N" (neutre) et "L" (phase).
- La tension d'alimentation AC peut être raccordée au bloc de connexion portant le texte "AC-in". Les plots de connexion sont clairement identifiés. "PE" (terre) "N" (neutre) et "L" (phase).

1.6 Raccordement d'options

Outre les raccordements standard, plusieurs options sont possibles.

1.6.1 Batterie de démarrage

Le Phoenix Multi est équipé d'une sortie auxiliaire pour la charge d'une batterie de démarrage. Pour le raccordement voir appendice A.

1.6.2 Détecteur de tension (Multi/ MultiPlus)

Afin de compenser d'éventuelles pertes de tension sur les câbles au cours de la charge, deux câbles de mesure peuvent y être raccordés sur la batterie. Utiliser un conducteur d'au moins 0,75mm². Pour le raccordement voir appendice A.

1.6.3 Sonde de température (Multi/ MultiPlus)

Pour la charge compensée en température, on peut connecter la sonde de température livrée (voir appendice A). La sonde est isolée et peut être montée sur le pôle négatif de la batterie.

GB

NL

F

D

Appendix

1.6.4 Commande à distance

Le Phoenix Multi peut être commandé à distance de deux façons.

- Au moyen d'un interrupteur externe simple.
- Au moyen d'un tableau de commande à distance.

Pour le raccordement du commutateur, voir appendice A.

Si le commutateur externe est seul utilisé, il est important de tenir compte des indications suivantes :

- Ne fonctionne que lorsque le commutateur du Phoenix Multi est positionné sur "on".
- Ne doit PAS être raccordé si le tableau de commande à distance est installé.

Pour le raccordement du tableau de commande à distance, voir appendice A.

Si le tableau de commande à distance est installé, tenir compte des indications suivantes :

- Ne fonctionne que lorsque le commutateur du Phoenix Multi est positionné sur "on".

1.6.5 Relais externe (Multi/ MultiPlus)

Pour pouvoir commuter plus de 16 Ampères, un relais externe peut être monté. Pour ce faire, s'adresser au votre fournisseur.

1.6.6 Raccordement en parallèle.

Le Phoenix Multi peut être raccordé en parallèle avec plusieurs appareils du même modèle, voir appendice G. Les batteries doivent être raccordées selon l'appendice E ou F. Le raccordement en parallèle permet de démultiplier la puissance de façon simple. Ce raccordement doit se faire au moyen d'un câble spécial livré par Victron Energy avec schéma de raccordement.

Le raccordement en parallèle ne doit se faire que dans la limite des conditions suivantes :

- Ne pas raccorder plus de cinq appareils en parallèle.
- Ne raccorder que des appareils du même type.
- S'assurer d'une capacité de batterie suffisante.
- Les sections des câbles indiqués (entre batterie et point de distribution) doivent être multipliés par le nombre d'appareils raccordés en parallèle.
- Placer les Multi près les uns des autres, tout en conservant un espace de ventilation suffisant, à peu près 10 cm.
- La sonde de température, le détecteur de tension, et la commande à distance doivent être raccordés sur l'appareil défini en 'master' (voir plus loin).
- Les câbles de chaque appareil doivent être de longueur égale (AC et DC).

1.6.7 Raccordement triphasé MultiPlus

Le Phoenix MultiPlus peut également être utilisé en triphasé, voir appendice O. Les batteries doivent être raccordées selon l'appendice E ou F. Pour le raccordement en triphasé, respecter les conditions suivantes :

- Ne raccorder en triphasé que des appareils du même type.
- S'assurer d'une capacité de batterie suffisante.
- Placer les MultiPlus près les uns des autres, tout en conservant une espace de ventilation suffisant.
- La sonde de température et le détecteur de tension doivent de préférence être raccordés sur les trois appareils.
- Une seule commande à distance peut être raccordée au moyen de séparateurs.

2. REGLAGES



- La modification des réglages doit être effectuée par un technicien qualifié.
- Lire attentivement les instructions avant toute modification.
- Pendant le réglage du chargeur, toutes les connexions vers la batterie doivent être déconnectées du Phoenix Multi.
- Ne pas raccorder de batteries non rechargeables.
- Ce Phoenix Multi est pré-réglé en usine pour la charge de batteries au gel de type Sonnenschein Dryfit A200. Pour la capacité de batterie recommandée, voir le paragraphe 1.4.
- Au cours de la charge, les batteries doivent être placées dans un endroit sec et bien ventilé.

2.1 Réglages - généralités

La modification des réglages peut se faire au moyen de boutons poussoirs et de commutateurs DIP (voir appendice A).

Les commutateurs DIP activent la configuration et déterminent le type de réglage. Les boutons poussoirs permettent de modifier les valeurs de réglage.

Les voyants LED permettent de lire les réglages. Les paragraphes 0 et 0 décrivent la lecture des voyants LED.

2.1.1 Réglages en usine

Pour rétablir les réglages de départ d'usine, enfoncer les deux boutons poussoirs pendant 3 secondes pendant que la configuration est activée.

Activation de la configuration

Activer la configuration par DS8 sur ON	Choisir un réglage par les DIP DS3 à DS7 et régler les nouvelles valeurs à l'aide des boutons.	Valider la configuration en déplaçant l'un des DIP DS3 à DS7	Désactiver la configuration par DS8 sur OFF

DS-1 et DS-2 sont réservés et doivent rester sur OFF.

ATTENTION : Les nouvelles valeurs ne sont enregistrées que lorsqu'un autre réglage a été sélectionné. Si la configuration est désactivée sans qu'un autre réglage ait été d'abord sélectionné, les nouvelles valeurs ne sont PAS enregistrées. Cette fonction permet de désactiver la configuration sans modification.

2.1.2 Lecture des LED choix multiple (Multi/ MultiPlus)

La formule suivante permet de déterminer la valeur d'un réglage :

$$\text{Valeur de réglage} = \text{chiffre} * \text{échelle} + \text{décalage}$$

Le 'décalage' et 'l'échelle' sont indiqués pour chaque réglage.

Le chiffre est indiqué par les LED de la façon suivante :

Les LED sont réparties en deux rangs de 4.

Chaque rang porte les chiffres de 0 à 9.

La combinaison des deux rangs donne des nombres à deux chiffres.

Le rang de gauche donne le chiffre de gauche, le rang de droite celui de droite.

Le chiffre d'une rangée se détermine par l'addition des 'valeurs' des LED.

Un voyant LED clignotant vaut 1 et un voyant LED allumé vaut 2.

4 LED clignotantes sont un cas particulier, et valent 9.

Symbole	Signification	Valeur LED
○	LED éteinte	0
☼	LED clignotante	1
●	LED allumée	2
☼ ☼ ☼ ☼	Toutes les LED d'un rang clignotent	9

Exemple de chiffres de réglage :

<table style="border-collapse: collapse; text-align: center;"> <tr><td>○</td><td>0</td><td>○</td><td>0</td></tr> <tr><td>○</td><td>0</td><td>●</td><td>2</td></tr> <tr><td>○</td><td>0</td><td>●</td><td>2</td></tr> <tr><td>○</td><td>0</td><td>●</td><td>2</td></tr> <tr><td colspan="2" style="border-top: 1px solid black;">0</td><td colspan="2" style="border-top: 1px solid black;">6</td></tr> </table>	○	0	○	0	○	0	●	2	○	0	●	2	○	0	●	2	0		6		=6	<table style="border-collapse: collapse; text-align: center;"> <tr><td>○</td><td>0</td><td>☼</td><td>1</td></tr> <tr><td>○</td><td>0</td><td>●</td><td>2</td></tr> <tr><td>●</td><td>2</td><td>●</td><td>2</td></tr> <tr><td>●</td><td>2</td><td>●</td><td>2</td></tr> <tr><td colspan="2" style="border-top: 1px solid black;">4</td><td colspan="2" style="border-top: 1px solid black;">7</td></tr> </table>	○	0	☼	1	○	0	●	2	●	2	●	2	●	2	●	2	4		7		=47	<table style="border-collapse: collapse; text-align: center;"> <tr><td>○</td><td>0</td><td>☼</td></tr> <tr><td>○</td><td>0</td><td>☼</td></tr> <tr><td>☼</td><td>1</td><td>☼</td></tr> <tr><td>●</td><td>2</td><td>☼</td></tr> <tr><td colspan="2" style="border-top: 1px solid black;">3</td><td style="border-top: 1px solid black;">9</td></tr> </table>	○	0	☼	○	0	☼	☼	1	☼	●	2	☼	3		9	=39
○	0	○	0																																																									
○	0	●	2																																																									
○	0	●	2																																																									
○	0	●	2																																																									
0		6																																																										
○	0	☼	1																																																									
○	0	●	2																																																									
●	2	●	2																																																									
●	2	●	2																																																									
4		7																																																										
○	0	☼																																																										
○	0	☼																																																										
☼	1	☼																																																										
●	2	☼																																																										
3		9																																																										

Le pas de réglage peut être inférieur à la l'affichage (valeur d'échelle). Dans ce cas, le bouton poussoir doit être enfoncé plusieurs fois pour modifier la valeur LED.

2.1.3 Lecture de LED double choix (Multi/ MultiPlus)

Outre la possibilité de déterminer une valeur en choix multiple, il y a aussi la possibilité d'un double choix. Cette fonction permet d'activer ou de désactiver un réglage. Dans le double choix, le rang de gauche donne l'option A et le rang de droite l'option B.

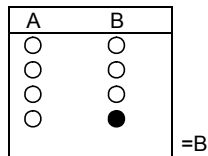
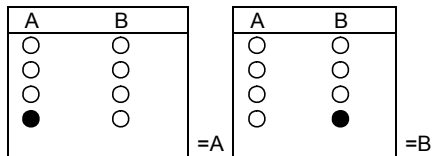

Le réglage d'usine est toujours A.

A la détermination de la valeur, les significations de A et B sont toujours indiquées.

2.1.4 Réglages par défaut

Fréquence système	50 Hz
Tension du convertisseur	230 Vac
Chargeur on/off	on
Caractéristique de Charge	Adaptative avec mode protection batterie
Courant de Charge	75% du courant maximum du Chargeur
Type de batterie	Type 1
Tension d'absorption	14.4/ 28.8/ 57.6 Vdc
Durée d'absorption/Durée d'absorption maximum	4 heures
Tension "float"	13.8/ 27.6/ 55.2 Vdc
Absorption répétée	1 heure
Intervalle des périodes d'absorption répétée	7 jours
Protection volumétrique (bulk) on/off	on
Contrôle de forme d'onde en entrée	on
Générateur/courant secteur/quai	16 A
Courant auxiliaire générateur/secteur	off
Configuration triphasé	off
Leader/ Follower	follower

GB

NL

F

D

Appendix

2.2 Fréquence système

Le Multi peut fonctionner en 50Hz ou en 60Hz.

Placer les DS 3 à 7	Ajuster la fréquence	Exemple										
DS-8 <input type="checkbox"/> DS-7 <input type="checkbox"/> off DS-6 <input type="checkbox"/> off DS-5 <input type="checkbox"/> on DS-4 <input type="checkbox"/> off DS-3 <input type="checkbox"/> off DS-2 <input type="checkbox"/> DS-1 <input type="checkbox"/>	Déterminer la fréquence voulue. Le réglage en usine est 50Hz. Le rang de LED de gauche est pour 50Hz. Le rang de LED de droite est pour 60Hz. Appuyer sur les boutons jusqu'à ce que les indications LED voulues apparaissent.	Choix : la fréquence est de 60 HZ. Indication LED = <table border="1" style="margin-left: 20px;"> <tr> <td>50Hz</td> <td>60Hz</td> </tr> <tr> <td><input type="checkbox"/></td> <td><input type="checkbox"/></td> </tr> <tr> <td><input type="checkbox"/></td> <td><input type="checkbox"/></td> </tr> <tr> <td><input type="checkbox"/></td> <td><input type="checkbox"/></td> </tr> <tr> <td><input type="checkbox"/></td> <td><input checked="" type="checkbox"/></td> </tr> </table>	50Hz	60Hz	<input type="checkbox"/>	<input type="checkbox"/>	<input type="checkbox"/>	<input type="checkbox"/>	<input type="checkbox"/>	<input type="checkbox"/>	<input type="checkbox"/>	<input checked="" type="checkbox"/>
50Hz	60Hz											
<input type="checkbox"/>	<input type="checkbox"/>											
<input type="checkbox"/>	<input type="checkbox"/>											
<input type="checkbox"/>	<input type="checkbox"/>											
<input type="checkbox"/>	<input checked="" type="checkbox"/>											

2.3 Réglage du convertisseur

Tension de sortie du convertisseur

La tension du convertisseur peut être réglée de 180Vac à 245Vac.

Placer les DS 3 à 7	Régler la tension	Exemple																								
DS-8 <input type="checkbox"/> DS-7 <input type="checkbox"/> on DS-6 <input type="checkbox"/> on DS-5 <input type="checkbox"/> off DS-4 <input type="checkbox"/> off DS-3 <input type="checkbox"/> off DS-2 <input type="checkbox"/> DS-1 <input type="checkbox"/>	Déterminer la tension V_q voulue Déterminer le chiffre de réglage : $échelle = 1V$ $décalage = 180V$ $chiffre\ de\ réglage = (V_q - 180)$ Déterminer l'indication LED. Appuyer sur les boutons jusqu'à ce que les indications LED voulues apparaissent.	Choix : la tension est de 225V. Chiffre de réglage = $225 - 180 = 45$. Indication LED = <table border="1" style="margin-left: 20px;"> <tr> <td><input type="checkbox"/></td> <td>0</td> <td><input type="checkbox"/></td> <td>0</td> </tr> <tr> <td><input type="checkbox"/></td> <td>0</td> <td><input checked="" type="checkbox"/></td> <td>1</td> </tr> <tr> <td><input checked="" type="checkbox"/></td> <td>2</td> <td><input checked="" type="checkbox"/></td> <td>2</td> </tr> <tr> <td><input checked="" type="checkbox"/></td> <td>2</td> <td><input checked="" type="checkbox"/></td> <td>2</td> </tr> <tr> <td></td> <td><hr/></td> <td></td> <td><hr/></td> </tr> <tr> <td></td> <td>4</td> <td></td> <td>5</td> </tr> </table>	<input type="checkbox"/>	0	<input type="checkbox"/>	0	<input type="checkbox"/>	0	<input checked="" type="checkbox"/>	1	<input checked="" type="checkbox"/>	2	<input checked="" type="checkbox"/>	2	<input checked="" type="checkbox"/>	2	<input checked="" type="checkbox"/>	2		<hr/>		<hr/>		4		5
<input type="checkbox"/>	0	<input type="checkbox"/>	0																							
<input type="checkbox"/>	0	<input checked="" type="checkbox"/>	1																							
<input checked="" type="checkbox"/>	2	<input checked="" type="checkbox"/>	2																							
<input checked="" type="checkbox"/>	2	<input checked="" type="checkbox"/>	2																							
	<hr/>		<hr/>																							
	4		5																							

Le pas de réglage est de 1V.

ATTENTION : Pour régler la tension du Phoenix Inverter il faut utiliser un multimètre car le Phoenix Inverter n'a que 4 LEDs.

2.4 Réglage du chargeur (Multi/ MultiPlus)

Pendant le réglage du chargeur, toutes les connexions vers la batterie doivent être déconnectées du Phoenix Multi.

Chargeur ON/ OFF

Le chargeur du Phoenix Multi peut être désactivé au besoin. La position standard est ON.

Placer les DS 3 à 7	Activer ou désactiver le chargeur	Exemple										
DS-8 <input type="checkbox"/> DS-7 <input type="checkbox"/> on DS-6 <input type="checkbox"/> off DS-5 <input type="checkbox"/> off DS-4 <input type="checkbox"/> on DS-3 <input type="checkbox"/> off DS-2 <input type="checkbox"/> DS-1 <input type="checkbox"/>	Déterminer si le chargeur doit être activé ou non. Le réglage en usine est 'activé'. Le rang de LED de gauche est pour 'activé'. Le rang de LED de droite est pour 'désactivé'. Appuyer sur les boutons jusqu'à ce que les indications LED voulues apparaissent.	Choix : le chargeur est Désactivé. Indication LED = <table border="1" style="margin-left: 20px;"> <thead> <tr> <th>Activé</th> <th>Désact.</th> </tr> </thead> <tbody> <tr> <td><input type="radio"/></td> <td><input type="radio"/></td> </tr> <tr> <td><input type="radio"/></td> <td><input type="radio"/></td> </tr> <tr> <td><input type="radio"/></td> <td><input type="radio"/></td> </tr> <tr> <td><input type="radio"/></td> <td><input checked="" type="radio"/></td> </tr> </tbody> </table>	Activé	Désact.	<input type="radio"/>	<input type="radio"/>	<input type="radio"/>	<input type="radio"/>	<input type="radio"/>	<input type="radio"/>	<input type="radio"/>	<input checked="" type="radio"/>
Activé	Désact.											
<input type="radio"/>	<input type="radio"/>											
<input type="radio"/>	<input type="radio"/>											
<input type="radio"/>	<input type="radio"/>											
<input type="radio"/>	<input checked="" type="radio"/>											

Caractéristiques de charge

Le Phoenix Multi présente 3 caractéristiques de charge.

La première, **Caractéristique de charge Fixe**, donne une tension d'absorption pendant une durée fixe (réglable). Après la phase d'absorption intervient pour une durée fixe (réglable) la tension flottante, la tension d'absorption revient ensuite périodiquement.

La **Caractéristique de charge Adaptative** donne une tension d'absorption pendant une durée qui dépendra de la durée de la charge "Bulk". Ensuite vient une phase de tension flottante de 24 heures, puis l'appareil vient à une tension flottante réduite de 13/ 26/ 52V. Comme pour les caractéristiques de charge Fixe, une phase d'absorption est ensuite appliquée périodiquement.

En **Mode de protection de batterie** la charge adaptative est en service mais la tension d'absorption fournie à la batterie est plus élevée. L'élévation de la tension est progressive et protège les batteries contre les endommagements par surcharge.

Placer les DS 3 à 7	Régler les caractéristiques de charge	Exemple																				
DS-8 <input type="checkbox"/> DS-7 <input type="checkbox"/> off DS-6 <input type="checkbox"/> on DS-5 <input type="checkbox"/> on DS-4 <input type="checkbox"/> on DS-3 <input type="checkbox"/> off DS-2 <input type="checkbox"/> DS-1 <input type="checkbox"/>	Déterminer les caractéristiques de charge nécessaires : 1: Fixe 2: Adaptatif 3: Adaptative avec Mode de protection des batteries (par défaut). Appuyer sur les boutons jusqu'à ce que les indications LED voulues apparaissent.	Choix : les caractéristiques de charge sont en Fixe. Chiffre de réglage = 1. Indication LED = <table border="1"> <tr><td><input type="radio"/></td><td>0</td><td><input type="radio"/></td><td>0</td></tr> <tr><td><input type="radio"/></td><td>0</td><td><input type="radio"/></td><td>0</td></tr> <tr><td><input type="radio"/></td><td>0</td><td><input type="radio"/></td><td>0</td></tr> <tr><td><input type="radio"/></td><td>0</td><td><input checked="" type="radio"/></td><td>1</td></tr> <tr><td colspan="2">0</td><td colspan="2">1</td></tr> </table>	<input type="radio"/>	0	<input type="radio"/>	0	<input type="radio"/>	0	<input type="radio"/>	0	<input type="radio"/>	0	<input type="radio"/>	0	<input type="radio"/>	0	<input checked="" type="radio"/>	1	0		1	
<input type="radio"/>	0	<input type="radio"/>	0																			
<input type="radio"/>	0	<input type="radio"/>	0																			
<input type="radio"/>	0	<input type="radio"/>	0																			
<input type="radio"/>	0	<input checked="" type="radio"/>	1																			
0		1																				

Courant de charge

Le courant de charge est réglé en standard sur 75% du maximum. Pour la plupart des applications, ce courant sera trop élevé. Pour éviter d'endommager les batteries, il est recommandé de régler le courant de charge à 10 – 20% de la capacité de batteries.

Placer les DS 3 à 7	Régler le courant de charge	Exemple																				
DS-8 <input type="checkbox"/> DS-7 <input type="checkbox"/> off DS-6 <input type="checkbox"/> on DS-5 <input type="checkbox"/> off DS-4 <input type="checkbox"/> off DS-3 <input type="checkbox"/> off DS-2 <input type="checkbox"/> DS-1 <input type="checkbox"/>	Déterminer le courant de charge voulu I_q . Déterminer le chiffre de réglage. $Echelle = 2A$ $Décalage = 0A$ $Chiffre\ de\ réglage = I_q/2$ Déterminer l'indication LED. Appuyer sur les boutons jusqu'à ce que les indications LED voulues apparaissent.	Capacité de batteries est de 450Ah. Le courant de charge maximum recommandé est de $450 \cdot 0,2 = 90A$ Chiffre de réglage = $90/2 = 45$. Indication LED = <table border="1"> <tr><td><input type="radio"/></td><td>0</td><td><input type="radio"/></td><td>0</td></tr> <tr><td><input type="radio"/></td><td>0</td><td><input checked="" type="radio"/></td><td>1</td></tr> <tr><td><input checked="" type="radio"/></td><td>2</td><td><input checked="" type="radio"/></td><td>2</td></tr> <tr><td><input checked="" type="radio"/></td><td>2</td><td><input checked="" type="radio"/></td><td>2</td></tr> <tr><td colspan="2">4</td><td colspan="2">5</td></tr> </table>	<input type="radio"/>	0	<input type="radio"/>	0	<input type="radio"/>	0	<input checked="" type="radio"/>	1	<input checked="" type="radio"/>	2	<input checked="" type="radio"/>	2	<input checked="" type="radio"/>	2	<input checked="" type="radio"/>	2	4		5	
<input type="radio"/>	0	<input type="radio"/>	0																			
<input type="radio"/>	0	<input checked="" type="radio"/>	1																			
<input checked="" type="radio"/>	2	<input checked="" type="radio"/>	2																			
<input checked="" type="radio"/>	2	<input checked="" type="radio"/>	2																			
4		5																				

Le pas de réglage est de 1A.

Types de batteries prédéfinis

Pour simplifier le réglage de la tension d'absorption et la tension flottante, et la durée d'absorption maximum, plusieurs types de batteries ont été prédéfinis :

	Type de batteries	Tension d'absorption			Tension flottante			Durée d'absorption maximum
0	Configuration utilisateur							
1	Sonnenschein Dryfit A200 Gel	14.4V	28.8V	57.6V	13.8 V/ 13.2V	27.6 V/ 26.4V	55.2 V/ 52.8V	4 heures
2	Traction	15.0V	30.0V	60.0V	13.8 V/ 13.2V	27.6 V/ 26.4V	55.2 V/ 52.8V	6 heures
3	Semi Traction ¹	14.4V	28.8V	57.6V	14.0 V/ 13.2V	28.0 V/ 26.4V	56.0 V/ 52.8V	5 heures
4	Victory ¹	14.8V	29.6V	59.2V	14.0 V/ 13.2V	28.0 V/ 26.4V	56.0 V/ 52.8V	5 heures

¹La tension d'absorption optimale des batteries à plaques au plomb-acide dépendent de leurs propriétés mécaniques et chimiques. Les batteries à haute teneur en antimoine peuvent généralement être chargées par une tension d'absorption plus basse que celles avec une teneur en antimoine moindre, telles que la batterie Victron à fibre de carbone. (Voir aussi la documentation 'L'électricité à bord des yachts' sur www.victronenergy.com)

Placer les DS 3 à 7	Régler le type de batteries	Exemple																				
DS-8 <input type="checkbox"/> DS-7 <input type="checkbox"/> on DS-6 <input type="checkbox"/> on DS-5 <input type="checkbox"/> off DS-4 <input type="checkbox"/> off DS-3 <input type="checkbox"/> on DS-2 <input type="checkbox"/> DS-1 <input type="checkbox"/>	Déterminer le type de batteries utilisé. Déterminer le chiffre de réglage selon le tableau. Appuyer sur les boutons jusqu'à l'indication LED désirée. ATTENTION : Le '0' ne peut pas être choisi mais sera affiché si la tension d'absorption, la tension flottante ou la durée d'absorption sont modifiés.	Choix : le type de batteries est Victory : Chiffre de réglage = 4. Indication LED = <table border="1" style="margin-left: 20px;"> <tr> <td><input type="radio"/></td><td>0</td> <td><input type="radio"/></td><td>0</td> </tr> <tr> <td><input type="radio"/></td><td>0</td> <td><input type="radio"/></td><td>0</td> </tr> <tr> <td><input type="radio"/></td><td>0</td> <td><input checked="" type="radio"/></td><td>2</td> </tr> <tr> <td><input type="radio"/></td><td>0</td> <td><input checked="" type="radio"/></td><td>2</td> </tr> <tr> <td colspan="2" style="text-align: center;">0</td> <td colspan="2" style="text-align: center;">4</td> </tr> </table>	<input type="radio"/>	0	<input type="radio"/>	0	<input type="radio"/>	0	<input type="radio"/>	0	<input type="radio"/>	0	<input checked="" type="radio"/>	2	<input type="radio"/>	0	<input checked="" type="radio"/>	2	0		4	
<input type="radio"/>	0	<input type="radio"/>	0																			
<input type="radio"/>	0	<input type="radio"/>	0																			
<input type="radio"/>	0	<input checked="" type="radio"/>	2																			
<input type="radio"/>	0	<input checked="" type="radio"/>	2																			
0		4																				

La disposition standard est pour la batterie gel Sonnenschein Dryfit A200.

Veuillez contacter votre revendeur de batteries pour la charge correcte ou le changement du voltage en cas de nécessité.

Tension d'absorption

La tension d'absorption peut être réglée de 12 à 16/ 24 à 32/ 48 à 64V. Pendant le réglage, la batterie, la sonde de température et le détecteur de tension doivent être déconnectés.

Placer les DS 3 à 7	Régler la tension d'absorption	Exemple										
DS-8 <input type="checkbox"/> DS-7 <input checked="" type="checkbox"/> on DS-6 <input type="checkbox"/> off DS-5 <input type="checkbox"/> off DS-4 <input type="checkbox"/> off DS-3 <input type="checkbox"/> off DS-2 <input type="checkbox"/> DS-1 <input type="checkbox"/>	Déterminer la tension d'absorption V_q . Déterminer le chiffre de réglage. <i>Echelle = 0,1V</i> <i>Décalage = 12/24V</i> <i>Chiffre de réglage = $(V_q - 24)/0,1$</i> Déterminer l'indication LED. Appuyer sur les boutons jusqu'à ce que les indications LED voulues apparaissent.	Choix : tension d'absorption = 28,5V. Chiffre de réglage = $(28,5-24)/0,1 = 45$. Indication LED = <table border="1" style="margin-left: 20px;"> <tr> <td>○ 0</td> <td>○ 0</td> </tr> <tr> <td>○ 0</td> <td>☀ 1</td> </tr> <tr> <td>● 2</td> <td>● 2</td> </tr> <tr> <td><u>2</u></td> <td><u>2</u></td> </tr> <tr> <td>4</td> <td>5</td> </tr> </table>	○ 0	○ 0	○ 0	☀ 1	● 2	● 2	<u>2</u>	<u>2</u>	4	5
○ 0	○ 0											
○ 0	☀ 1											
● 2	● 2											
<u>2</u>	<u>2</u>											
4	5											

Le pas de réglage est de 0,05 V.

Durée d'absorption/ durée d'absorption maximum

Ce réglage détermine en caractéristiques de charge fixe, la durée de tension d'absorption fournie par le chargeur. En caractéristiques de charge adaptative, ce réglage détermine la période maximum de tension d'absorption fournie par le chargeur. La durée (maximum) d'absorption peut être réglée de 1 à 8 heures.

Placer les DS 3 à 7	Régler la durée d'absorption (maximum)	Exemple												
DS-8 <input type="checkbox"/> DS-7 <input checked="" type="checkbox"/> on DS-6 <input checked="" type="checkbox"/> on DS-5 <input checked="" type="checkbox"/> on DS-4 <input type="checkbox"/> off DS-3 <input type="checkbox"/> off DS-2 <input type="checkbox"/> DS-1 <input type="checkbox"/>	Déterminer la durée d'absorption (maximum) T_q . Déterminer le chiffre de réglage. <i>Echelle = 1 heure</i> <i>Décalé = 0</i> <i>Chiffre de réglage = T_q</i> Déterminer l'indication LED. Appuyer sur les boutons jusqu'à ce que les indications LED voulues apparaissent.	Choix : Durée d'absorption maximum = 4 heures. Chiffre de réglage = 4. Indication LED = <table border="1" style="margin-left: 20px;"> <tr> <td>○ 0</td> <td>○ 0</td> </tr> <tr> <td>○ 0</td> <td>○ 0</td> </tr> <tr> <td>○ 0</td> <td>● 2</td> </tr> <tr> <td>○ 0</td> <td>● 2</td> </tr> <tr> <td><u>0</u></td> <td><u>2</u></td> </tr> <tr> <td>0</td> <td>4</td> </tr> </table>	○ 0	○ 0	○ 0	○ 0	○ 0	● 2	○ 0	● 2	<u>0</u>	<u>2</u>	0	4
○ 0	○ 0													
○ 0	○ 0													
○ 0	● 2													
○ 0	● 2													
<u>0</u>	<u>2</u>													
0	4													

Le pas de réglage est de 1 heure.

Tension flottante

La tension flottante est réglable de 12 à 16/ 24 à 32/ 48 à 64V. Pendant le réglage, la batterie, la sonde de température et le détecteur de tension doivent être déconnectés.

Placer les DS 3 à 7	Régler la tension flottante	Exemple										
DS-8 <input type="checkbox"/> DS-7 <input checked="" type="checkbox"/> on DS-6 <input type="checkbox"/> off DS-5 <input type="checkbox"/> off DS-4 <input type="checkbox"/> off DS-3 <input type="checkbox"/> off DS-2 <input type="checkbox"/> DS-1 <input type="checkbox"/>	Déterminer la tension flottante V_q . Déterminer le chiffre de réglage. $Echelle = 0,1V$ $Minimum = 12/24V$ $Chiffre\ de\ réglage = (V_q - 24)/0,1$ Déterminer l'indication LED. Appuyer sur les boutons jusqu'à ce que les indications LED voulues apparaissent.	Choix : Tension flottante = 28,5V. Chiffre de réglage = $(28,5-24)/0,1 = 45$. Indication LED = <table border="1" style="display: inline-table; vertical-align: middle;"> <tr> <td>○ 0</td> <td>○ 0</td> </tr> <tr> <td>○ 0</td> <td>☀ 1</td> </tr> <tr> <td>● 2</td> <td>● 2</td> </tr> <tr> <td>● 2</td> <td>● 2</td> </tr> <tr> <td style="border-top: 1px solid black;">4</td> <td style="border-top: 1px solid black;">5</td> </tr> </table>	○ 0	○ 0	○ 0	☀ 1	● 2	● 2	● 2	● 2	4	5
○ 0	○ 0											
○ 0	☀ 1											
● 2	● 2											
● 2	● 2											
4	5											

Le pas de réglage est de 0,05 V.

Absorption répétée

Après chaque cycle de charge, et après la phase flottante, le chargeur revient périodiquement en charge d'absorption. Ceci est dénommé 'période d'absorption répétée', voir appendice C.

Période d'absorption répétée

La période d'absorption répétée peut être réglée de 1 à 72 quarts d'heure.

Placer les DS 3 à 7	Régler la période d'absorption répétée	Exemple										
DS-8 <input type="checkbox"/> DS-7 <input checked="" type="checkbox"/> on DS-6 <input checked="" type="checkbox"/> on DS-5 <input checked="" type="checkbox"/> on DS-4 <input type="checkbox"/> off DS-3 <input type="checkbox"/> off DS-2 <input type="checkbox"/> DS-1 <input type="checkbox"/>	Déterminer la période d'absorption répétée T_q en quarts d'heure. Déterminer le chiffre de réglage. $Echelle = 1\ quart\ d'heure$ $Décalage = 0$ $Chiffre\ de\ réglage = T_q$ Déterminer l'indication LED. Appuyer sur les boutons jusqu'à ce que les indications LED voulues apparaissent.	Choix : La période d'absorption répétée est de 1 heure. Chiffre de réglage = 1 heure = 4 quarts d'heure Indication LED= <table border="1" style="display: inline-table; vertical-align: middle;"> <tr> <td>○ 0</td> <td>○ 0</td> </tr> <tr> <td>○ 0</td> <td>○ 0</td> </tr> <tr> <td>○ 0</td> <td>● 2</td> </tr> <tr> <td>○ 0</td> <td>● 2</td> </tr> <tr> <td style="border-top: 1px solid black;">0</td> <td style="border-top: 1px solid black;">4</td> </tr> </table>	○ 0	○ 0	○ 0	○ 0	○ 0	● 2	○ 0	● 2	0	4
○ 0	○ 0											
○ 0	○ 0											
○ 0	● 2											
○ 0	● 2											
0	4											

Le pas de réglage est de 1 quart d'heure.

Intervalle de périodes d'absorption répétée

L'intervalle de périodes d'absorption répétée, ou encore floating réduit, peut être réglé de 1 à 45 jours.

Placer les DS 3 à 7	Régler l'intervalle de périodes d'absorption répétée (floating réduit)	Exemple																																								
<table border="1"> <tr><td>DS-8</td><td></td></tr> <tr><td>DS-7</td><td>off</td></tr> <tr><td>DS-6</td><td>off</td></tr> <tr><td>DS-5</td><td>off</td></tr> <tr><td>DS-4</td><td>on</td></tr> <tr><td>DS-3</td><td>off</td></tr> <tr><td>DS-2</td><td></td></tr> <tr><td>DS-1</td><td></td></tr> </table>	DS-8		DS-7	off	DS-6	off	DS-5	off	DS-4	on	DS-3	off	DS-2		DS-1		<p>Déterminer la période de floating Tq.</p> <p>Déterminer le chiffre de réglage. <i>Echelle = 1 jour</i> <i>Décalage = 0</i> <i>Chiffre de réglage = Tq</i></p> <p>Déterminer l'indication LED.</p> <p>Appuyer sur les boutons jusqu'à ce que les indications LED voulues apparaissent.</p>	<p>Choix : Floating réduit = 1 semaine.</p> <p>Chiffre de réglage = 7.</p> <p>Indication LED=</p> <table border="1"> <tr> <td><input type="radio"/></td> <td>0</td> <td><input type="radio"/></td> <td>1</td> </tr> <tr> <td><input type="radio"/></td> <td>0</td> <td><input checked="" type="radio"/></td> <td>2</td> </tr> <tr> <td><input type="radio"/></td> <td>0</td> <td><input checked="" type="radio"/></td> <td>2</td> </tr> <tr> <td><input type="radio"/></td> <td>0</td> <td><input checked="" type="radio"/></td> <td>2</td> </tr> <tr> <td colspan="2"><hr/></td> <td colspan="2"><hr/></td> </tr> <tr> <td></td> <td>0</td> <td></td> <td>7</td> </tr> </table>	<input type="radio"/>	0	<input type="radio"/>	1	<input type="radio"/>	0	<input checked="" type="radio"/>	2	<input type="radio"/>	0	<input checked="" type="radio"/>	2	<input type="radio"/>	0	<input checked="" type="radio"/>	2	<hr/>		<hr/>			0		7
DS-8																																										
DS-7	off																																									
DS-6	off																																									
DS-5	off																																									
DS-4	on																																									
DS-3	off																																									
DS-2																																										
DS-1																																										
<input type="radio"/>	0	<input type="radio"/>	1																																							
<input type="radio"/>	0	<input checked="" type="radio"/>	2																																							
<input type="radio"/>	0	<input checked="" type="radio"/>	2																																							
<input type="radio"/>	0	<input checked="" type="radio"/>	2																																							
<hr/>		<hr/>																																								
	0		7																																							

Le pas de réglage est de 1 jour.

2.5 Réglages spéciaux

Protection volumétrique (bulk) ON/ OFF

Si après 10 heures de charge maximum (phase bulk) le chargeur n'a pas atteint la tension d'absorption, il se peut que la batterie soit défectueuse. Pour éviter plus de dégradation, le chargeur est arrêté automatiquement au bout de 10 heures de charge maximum. La LED "bulk" commence alors à clignoter. Cette sécurité peut être désactivée.

Placer les DS 3 à 7	Activer ou désactiver la protection de charge volumétrique	Exemple										
DS-8 <input type="checkbox"/> DS-7 <input type="checkbox"/> off DS-6 <input type="checkbox"/> on DS-5 <input type="checkbox"/> off DS-4 <input type="checkbox"/> on DS-3 <input type="checkbox"/> off DS-2 <input type="checkbox"/> DS-1 <input type="checkbox"/>	Déterminer si la protection de charge volumétrique doit être activée ou désactivée. Le réglage en usine est 'activé'. Le rang de LED de gauche est pour 'activé'. Le rang de LED de droite est pour 'désactivé'. Appuyer sur les boutons jusqu'à ce que les indications LED voulues apparaissent.	Choix : La protection de charge volumétrique est désactivée. Indication LED= <table border="1"> <thead> <tr> <th>Activé</th> <th>Désactivé</th> </tr> </thead> <tbody> <tr> <td><input type="checkbox"/></td> <td><input type="checkbox"/></td> </tr> <tr> <td><input type="checkbox"/></td> <td><input type="checkbox"/></td> </tr> <tr> <td><input type="checkbox"/></td> <td><input type="checkbox"/></td> </tr> <tr> <td><input type="checkbox"/></td> <td><input checked="" type="checkbox"/></td> </tr> </tbody> </table>	Activé	Désactivé	<input type="checkbox"/>	<input type="checkbox"/>	<input type="checkbox"/>	<input type="checkbox"/>	<input type="checkbox"/>	<input type="checkbox"/>	<input type="checkbox"/>	<input checked="" type="checkbox"/>
Activé	Désactivé											
<input type="checkbox"/>	<input type="checkbox"/>											
<input type="checkbox"/>	<input type="checkbox"/>											
<input type="checkbox"/>	<input type="checkbox"/>											
<input type="checkbox"/>	<input checked="" type="checkbox"/>											

Contrôle de forme d'onde

Le Phoenix Multi contrôle sa tension d'alimentation mais aussi la forme d'onde. Si le Phoenix Multi ne fonctionne pas bien sur un générateur cette fonction peut être désactivée.

Placer les DS 3 à 7	Activer ou désactiver la fonction Mains Voltage Check	Exemple										
DS-8 <input type="checkbox"/> DS-7 <input type="checkbox"/> off DS-6 <input type="checkbox"/> on DS-5 <input type="checkbox"/> off DS-4 <input type="checkbox"/> off DS-3 <input type="checkbox"/> on DS-2 <input type="checkbox"/> DS-1 <input type="checkbox"/>	Déterminer si Mains Voltage Check doit être activé ou désactivé. Le réglage en usine est 'activé'. Le rang de LED de gauche est pour 'activé'. Le rang de LED de droite est pour 'désactivé'. Appuyer sur les boutons jusqu'à ce que les indications LED voulues apparaissent.	Choix: Mains Waveform Check est désactivée. Indication LED= <table border="1"> <thead> <tr> <th>Activé</th> <th>Désactivé</th> </tr> </thead> <tbody> <tr> <td><input type="checkbox"/></td> <td><input type="checkbox"/></td> </tr> <tr> <td><input type="checkbox"/></td> <td><input type="checkbox"/></td> </tr> <tr> <td><input type="checkbox"/></td> <td><input type="checkbox"/></td> </tr> <tr> <td><input type="checkbox"/></td> <td><input checked="" type="checkbox"/></td> </tr> </tbody> </table>	Activé	Désactivé	<input type="checkbox"/>	<input type="checkbox"/>	<input type="checkbox"/>	<input type="checkbox"/>	<input type="checkbox"/>	<input type="checkbox"/>	<input type="checkbox"/>	<input checked="" type="checkbox"/>
Activé	Désactivé											
<input type="checkbox"/>	<input type="checkbox"/>											
<input type="checkbox"/>	<input type="checkbox"/>											
<input type="checkbox"/>	<input type="checkbox"/>											
<input type="checkbox"/>	<input checked="" type="checkbox"/>											

PowerControl : limitation du courant d'entrée

Pour la protection du générateur ou de la connexion au secteur (quai), le courant d'alimentation est réglé de façon à ce que les puissances additionnées du chargeur et des utilisations ne dépassent pas un niveau déterminé.

Si la consommation AC dépasse ce niveau, le chargeur est désactivé et la LED "mains on" clignote. Il est alors possible que le disjoncteur secteur (quai) se déclenche ou que le générateur s'arrête en raison de surcharge. Dans ce cas, le Multi tente de commuter sur la fonction convertisseur.

La puissance générateur/ courant secteur peut être réglée de 1 à 16A.

Placer les DS 3 à 7	Régler le courant d'alimentation.	Exemple																				
DS-8 <input type="checkbox"/> DS-7 <input type="checkbox"/> off DS-6 <input type="checkbox"/> on DS-5 <input type="checkbox"/> on DS-4 <input type="checkbox"/> off DS-3 <input type="checkbox"/> off DS-2 <input type="checkbox"/> DS-1 <input type="checkbox"/>	Déterminer la limite de courant d'alimentation Iq. Déterminer le chiffre de réglage. <i>Echelle = 1A</i> <i>Décalage = 0</i> <i>Chiffre de réglage = (Iq)/1</i> Déterminer l'indication LED. Appuyer sur les boutons jusqu'à ce que les indications LED voulues apparaissent.	Choix : la limite de courant d'alimentation est de 16A. Chiffre de réglage = 16. Indication LED= <table border="1"> <tr> <td><input type="checkbox"/></td> <td>0</td> <td><input type="checkbox"/></td> <td>0</td> </tr> <tr> <td><input type="checkbox"/></td> <td>0</td> <td><input checked="" type="checkbox"/></td> <td>2</td> </tr> <tr> <td><input type="checkbox"/></td> <td>0</td> <td><input checked="" type="checkbox"/></td> <td>2</td> </tr> <tr> <td><input checked="" type="checkbox"/></td> <td>1</td> <td><input checked="" type="checkbox"/></td> <td>2</td> </tr> <tr> <td></td> <td>1</td> <td></td> <td>6</td> </tr> </table>	<input type="checkbox"/>	0	<input type="checkbox"/>	0	<input type="checkbox"/>	0	<input checked="" type="checkbox"/>	2	<input type="checkbox"/>	0	<input checked="" type="checkbox"/>	2	<input checked="" type="checkbox"/>	1	<input checked="" type="checkbox"/>	2		1		6
<input type="checkbox"/>	0	<input type="checkbox"/>	0																			
<input type="checkbox"/>	0	<input checked="" type="checkbox"/>	2																			
<input type="checkbox"/>	0	<input checked="" type="checkbox"/>	2																			
<input checked="" type="checkbox"/>	1	<input checked="" type="checkbox"/>	2																			
	1		6																			

Le pas de réglage est de 1A.

Avec l'utilisation d'un tableau de commande à distance, le réglage de courant d'alimentation est effectué sur la commande à distance.

PowerAssist : Courant auxiliaire générateur/ secteur ^{MultiPlus}

Si le générateur ou le secteur (quai) ne fournit pas assez de puissance, le Phoenix MultiPlus peut fournir un complément à partir de la batterie. La batterie est ainsi économisée puisqu'elle n'a pas à fournir toute la puissance mais seulement un complément.

Cette fonction peut être activée.

Placer les DS 3 à 7	Positionner cette fonction 'generator support' sur ON ou OFF	Exemple										
DS-8 <input type="checkbox"/> DS-7 <input type="checkbox"/> on DS-6 <input type="checkbox"/> off DS-5 <input type="checkbox"/> on DS-4 <input type="checkbox"/> off DS-3 <input type="checkbox"/> off DS-2 <input type="checkbox"/> DS-1 <input type="checkbox"/>	Déterminer si la fonction de puissance auxiliaire doit être activée ou non. Le réglage en usine est 'désactivé'. Le rang de LED de gauche est pour OFF. Le rang de LED de droite est pour ON. Appuyer sur les boutons jusqu'à ce que les indications LED voulues apparaissent.	Choix : La puissance auxiliaire est activée. Indication LED= <table border="1"> <thead> <tr> <th>Désactivé</th> <th>Activé</th> </tr> </thead> <tbody> <tr> <td><input type="checkbox"/></td> <td><input type="checkbox"/></td> </tr> <tr> <td><input type="checkbox"/></td> <td><input type="checkbox"/></td> </tr> <tr> <td><input type="checkbox"/></td> <td><input type="checkbox"/></td> </tr> <tr> <td><input type="checkbox"/></td> <td><input checked="" type="checkbox"/></td> </tr> </tbody> </table>	Désactivé	Activé	<input type="checkbox"/>	<input type="checkbox"/>	<input type="checkbox"/>	<input type="checkbox"/>	<input type="checkbox"/>	<input type="checkbox"/>	<input type="checkbox"/>	<input checked="" type="checkbox"/>
Désactivé	Activé											
<input type="checkbox"/>	<input type="checkbox"/>											
<input type="checkbox"/>	<input type="checkbox"/>											
<input type="checkbox"/>	<input type="checkbox"/>											
<input type="checkbox"/>	<input checked="" type="checkbox"/>											

Configuration en triphasé ^{MultiPlus}

Pour établir un réseau triphasé, trois appareils Phoenix MultiPlus du même type doivent être connectés entre eux, selon appendice 0. Les batteries doivent être connectées selon appendice E ou F. Ensuite quelques réglages par appareil sont nécessaires.

En premier lieu, tous les appareils doivent être réglés pour le fonctionnement en triphasé.

Placer les DS 3 à 7	Mettre la fonction triphasé sur ON ou OFF	Exemple										
DS-8 <input type="checkbox"/> DS-7 <input type="checkbox"/> on DS-6 <input type="checkbox"/> on DS-5 <input type="checkbox"/> off DS-4 <input type="checkbox"/> on DS-3 <input type="checkbox"/> off DS-2 <input type="checkbox"/> DS-1 <input type="checkbox"/>	Déterminer si la fonction triphasé doit être sur ON ou OFF. Le réglage en usine est 'désactivé'. Le rang de LED de gauche est pour OFF. Le rang de LED de droite est pour ON. Appuyer sur les boutons jusqu'à ce que les indications LED voulues apparaissent.	Choix : La fonction triphasé est activée. Indication LED= <table border="1"> <thead> <tr> <th>Désactivé</th> <th>Activé</th> </tr> </thead> <tbody> <tr> <td><input type="radio"/></td> <td><input type="radio"/></td> </tr> <tr> <td><input type="radio"/></td> <td><input type="radio"/></td> </tr> <tr> <td><input type="radio"/></td> <td><input type="radio"/></td> </tr> <tr> <td><input type="radio"/></td> <td><input checked="" type="radio"/></td> </tr> </tbody> </table>	Désactivé	Activé	<input type="radio"/>	<input type="radio"/>	<input type="radio"/>	<input type="radio"/>	<input type="radio"/>	<input type="radio"/>	<input type="radio"/>	<input checked="" type="radio"/>
Désactivé	Activé											
<input type="radio"/>	<input type="radio"/>											
<input type="radio"/>	<input type="radio"/>											
<input type="radio"/>	<input type="radio"/>											
<input type="radio"/>	<input checked="" type="radio"/>											

Ensuite, un des trois appareils doit être défini comme "maître". En configuration triphasée il se nomme "Leader". Les autres appareils n'ont pas besoin d'autre réglage.

Placer les DS 3 à 7	Déterminer les Leader/ Follower	Exemple										
DS-8 <input type="checkbox"/> DS-7 <input type="checkbox"/> off DS-6 <input type="checkbox"/> off DS-5 <input type="checkbox"/> on DS-4 <input type="checkbox"/> on DS-3 <input type="checkbox"/> off DS-2 <input type="checkbox"/> DS-1 <input type="checkbox"/>	Déterminer comme Leader ou Follower. Le réglage en usine est Follower. Le rang LED de gauche est pour Follower. Le rang LED de droite est pour Leader. Appuyer sur les boutons jusqu'à ce que les indications LED voulues apparaissent.	Choix : Cet appareil est en Leader. Indication LED= <table border="1"> <thead> <tr> <th>Follower</th> <th>Leader</th> </tr> </thead> <tbody> <tr> <td><input type="radio"/></td> <td><input type="radio"/></td> </tr> <tr> <td><input type="radio"/></td> <td><input type="radio"/></td> </tr> <tr> <td><input type="radio"/></td> <td><input type="radio"/></td> </tr> <tr> <td><input type="radio"/></td> <td><input checked="" type="radio"/></td> </tr> </tbody> </table>	Follower	Leader	<input type="radio"/>	<input type="radio"/>	<input type="radio"/>	<input type="radio"/>	<input type="radio"/>	<input type="radio"/>	<input type="radio"/>	<input checked="" type="radio"/>
Follower	Leader											
<input type="radio"/>	<input type="radio"/>											
<input type="radio"/>	<input type="radio"/>											
<input type="radio"/>	<input type="radio"/>											
<input type="radio"/>	<input checked="" type="radio"/>											

2.6 Entretien

Le Phoenix Multi ne nécessite pas d'entretien spécifique. Il suffit de contrôler l'ensemble des connexions une fois par an. Eviter toute humidité du Phoenix Multi et le maintenir le plus propre possible.

3. SCHEMA DE DEPISTAGE DE DEFAUTS

Les étapes suivantes permettent de dépister rapidement certains défauts. Avant de tester le convertisseur et/ ou le chargeur de batteries les utilisations en DC doivent être déconnectées de la batterie et les appareils AC doivent être déconnectés du convertisseur.

Si la panne n'est pas trouvée, consulter votre distributeur Victron Energy.

Problème	Origine	Solution
Le convertisseur ne fonctionne pas lorsqu'il est enclenché.	La tension de batterie est trop haute ou trop basse.	Faites le nécessaire pour atteindre la valeur correcte.
La LED "low battery" clignote.	La tension de batterie est faible.	Charger la batterie et contrôler le raccordement.
La LED "low battery" est allumée.	Le convertisseur s'arrête parce que la tension de batterie est trop faible.	Charger la batterie et contrôler le raccordement.
La LED "overload" clignote.	La demande sur le convertisseur dépasse sa puissance nominale.	Déconnecter une partie de la puissance demandée.
La LED "overload" est allumée.	Le convertisseur est arrêté en raison d'une demande trop forte.	Déconnecter une partie de la puissance demandée.
La LED "temperature" clignote ou est allumée.	La température ambiante est trop élevée ou la demande en puissance est trop forte.	Placer l'appareil dans un endroit plus frais et bien ventilé ou déconnecter une partie de la puissance demandée.
Les LED "low battery" et "overload" clignotent à tour de rôle.	Tension de batterie faible et demande trop forte.	Charger la batterie, déconnecter une partie de la puissance demandée, ou placer une batterie de plus grande capacité. Monter des câbles de batterie plus courts et/ ou plus forts. Contrôler la dynamo.
Les LED "low battery" et "overload" clignotent en même temps.	Ondulation de tension sur la connexion DC dépasse 1,25Vrms.	Contrôler les câbles et raccordements de batterie. Assurer-vous que la capacité de batterie soit suffisante et augmenter-la au besoin.
Les LED "low battery" et "overload" sont allumées.	Le convertisseur est arrêté en raison d'ondulation de tension trop forte sur l'arrivée.	Placer une batterie de plus forte capacité. Monter des câbles de batterie plus courts et/ ou plus forts et remettre le convertisseur à zéro (déconnecté/ reconnecté).

Problème	Origine	Solution
Une LED d'alarme est allumée et la seconde clignote	Le convertisseur est arrêté en raison du signal d'alarme de la LED allumée. La LED clignotante indique que le convertisseur est presque arrêté en raison de l'alarme.	Consulter ce tableau pour déterminer l'action à entreprendre.
Le chargeur ne fonctionne pas.	Le courant ou la fréquence secteur sont hors tolérances.	Le courant secteur doit être entre 185 Vac et 265 Vac et la fréquence doit correspondre à la configuration.
	Le disjoncteur thermique est activé.	Réarmer le disjoncteur thermique 16 A.
La charge de la batterie ne se fait pas complètement.	Le courant de charge est incorrect.	Régler le courant de charge de 0,1 à 0,2x la capacité de batterie.
	Le raccordement de la batterie est défectueux.	Contrôler le raccordement de la batterie.
	La tension d'absorption est réglée sur une valeur incorrecte.	Régler la tension d'absorption sur la valeur correcte.
	La tension flottante est réglée sur une valeur incorrecte.	Régler la tension flottante sur la valeur correcte.
	La capacité de la batterie est trop élevée.	Raccorder une batterie de moindre capacité et augmenter le courant de charge.
La batterie est surchargée.	Le fusible de sortie est défectueux.	Remplacer le fusible de sortie.
	La tension d'absorption est réglée sur une valeur incorrecte.	Régler la tension d'absorption sur la valeur correcte.
	La tension flottante est réglée sur une valeur incorrecte.	Régler la tension flottante sur la valeur correcte.
	Batterie défectueuse.	Remplacer la batterie.
	Batterie trop faible.	Réduire le courant de charge ou utiliser une batterie de plus forte capacité.
	La température de la batterie est trop élevée.	Raccorder une sonde de température.

GB

NL

F

D

Appendix

4. SPECIFICATIONS TECHNIQUES

Phoenix Multi/MultiPlus	12/2000/100	12/3000/120	24/2000/60	24/3000/70	48/3000/35
ONDULEUR					
Plage de tension d'entrée (Vdc)	9,5-16,1	9,5-16,1	19,0-32,2	19,0-32,2	38,0-64,4
Tension de sortie (Vac)	230 ± 2%				
Fréquence (Hz) (1)	50 ± 0,1%				
Puissance permanente 25°C	2000	3000	2000	3000	3000
Puissance permanente 25°C	1800	2500	1800	2500	2500
Puissance permanente 40°C	1400	1600	1500	2000	2000
Puissance maxi (W)	4000	4500	4000	6000	6000
Rendement maxi (%)	93	93	94	94	95
Puissance à vide (economy) (W)	6	6	6	6	10
CHARGEUR					
Plage de tension d'entrée (Vac)	187-265				
Fréquence d'entrée (Hz)	45 - 55				
Facteur de puissance	1				
Tension 'absorption' (Vdc)	14,4	14,4	28,8	28,8	57,6
Tension 'floating' (Vdc)	13,8	13,8	27,6	27,6	55,2
Tension stockage (Vdc)	13,2	13,2	26,4	26,4	52,8
Courant batt. de service (A) (4)	100	120	60	70	35
Courant batt. démarrage (A)	4	4	4	4	4
Capacité batterie (Ah)	300-1000	400-1200	150-600	200-700	100-400
Sonde de température	√	√	√	√	√

GB

NL

F

D

Appendix

Phoenix Multi/MultiPlus	12/2000/100	12/3000/120	24/2000/60	24/3000/70	48/3000/35
GENERAL					
Relais	√ (6)				
Ventilation forcée	√				
Sécurités (2)	a - h				
Plage de temp. de fonctionnement	-20 - 50°C				
Humidité (sans ruissellement)	max 95%				
BOÎTIER					
Matériau & couleur	aluminium (bleu RAL 5012)				
Raccordement batterie	boulons M8				
Raccordement 230 Vac	bornes à vis 2,5 mm ²				
Degré de protection	IP 21				
Poids (kg)	18	18	18	18	18
Dimensions (hxlxp) en mm)	362x258x218				
CONFORMITE AUX NORMES					
Sécurité	EN 60335-1, EN 60335-2-29				
Emission	EN 50081-1, EN55014, EN 61000-3-2, EN 61000-3-3				
Immunité	EN 55014-2				
Directive Automobile	95/54/EC				n. a.

1) réglage 60 Hz possible

2) Sécurités

a. Court-circuit sur la sortie

b. Surcharge

c. Tension batterie trop élevée

d. Tension batterie trop basse

e. Inversion de polarité batterie

f. 230 Vac en sortie

g. Ondulation trop forte sur l'entrée

h. Température

3) Non disponible en version MultiPlus

4) A 25°C temp. ambiante

5) Charge non-linéaire, facteur crête 3:1

6) Relais utilisable comme alarme générale, alarme basse tension ou relais de démarrage pour un générateur.

1. INSTALLATION



Der Phoenix Multi darf nur von qualifizierten Elektroinstallateuren installiert werden.

GB

NL

F

D

Appendix

1.1 Verpackungsinhalt

Die Verpackung des Phoenix Multi enthält folgende Einzelteile:

- Phoenix Multi,
- Bedienungsanleitung,
- Installationsanleitung,
- Verpackung mit Anschlussmaterial:
 - Temperaturfühler,
 - Sicherung (Mega fuse),
 - vier Muttern M8,
 - vier Beilagscheiben M8,
 - vier Federscheiben M8,
 - Aufkleber mit Warnhinweis Ladestrom.

1.2 Aufstellungsort

Der Phoenix Multi muss in einem trockenen, gut ventilerten Raum installiert werden, direkt neben den Batterien. Zur Luftzirkulation muss um das Gerät herum ein Raum von mindestens 50mm frei gelassen werden.



Eine zu hohe Raumtemperatur kann folgende Auswirkungen haben:

- kürzere Lebensdauer,
- geringerer Ladestrom,
- geringere Spitzenleistung oder komplettes Abschalten des Umformers.

Stellen Sie das Gerät niemals direkt über die Batterien.

Der Phoenix Multi ist auch zur Wandmontage geeignet. Zum Befestigen des Geräts sind an der Rückseite des Gehäuses zwei Löcher angebracht. Siehe Appendix. B
Das Gerät kann sowohl horizontal wie auch vertikal montiert werden. Allerdings sollte, wenn möglich, vertikal montiert werden, Da dies die optimale Position für die Kühlung des Geräts ist.



Der Innenbereich des Gerät muss auch nach der Installation noch gut zu erreichen sein.

Sorgen Sie dafür, dass die Anschlusskabel über Sicherungen und Stromunterbrecher verfügen. Um den Spannungsverlust über die Kabel möglichst gering zu halten, sollte der Abstand zwischen dem Phoenix Multi und der Batterie so kurz wie möglich sein.



In allen Geräten, in denen eine hohe elektrische Leistung umgeformt wird, muss dieses Produkt vorsorglich in einer hitzebeständigen Umgebung installiert werden. So sollten sich zum Beispiel Chemikalien, Kunststoffgegenstände, Gardinen oder andere Textilien usw. möglichst nicht in der direkten Umgebung befinden.

1.3 Benötigtes Werkzeug und Kabel

- Kreuz-Schlitz-Schraubenzieher (PH 2) zum Abnehmen der Vorderfront,
- flacher Schraubenzieher (0,6x3,5) zum Anschließen der AC-Kabel,
- isolierter Rohrschlüssel (13 mm) zum Anziehen der Verbindungsschrauben und der Sicherung,
- zwei Batteriekabel (maximal 6 Meter lang) einschließlich Batterieklemmen und Kabelösen,
- dreiadriges Kabel.

1.4 Batteriekabel anschließen

Um die Kapazität des Phoenix Multi voll ausnützen zu können, sollten nur Batterien mit ausreichend Kapazität und Batteriekabel mit der richtigen Stärke verwendet werden . Siehe Tabelle.

	12/2000/100	12/3000/120	24/2000/60	24/3000/70	48/3000/35
Empfohlene Batteriekapazität (Ah)	200–700	400–1200	100–400	200–700	100–400
Empfohlene Kabelstärke (mm ²)					
0 – 5 m	70	90	40	50	35
5 – 10 m	100	120	70	90	70

Vorgehensweise

Gehen Sie beim Anschließen der Batteriekabel wie folgt vor:



Um einen Kurzschluss in der Batterie zu vermeiden, sollten Sie mit einem isolierten Rohrschlüssel arbeiten.

Achten Sie darauf, dass in den Batteriekabeln kein Kurzschluss entsteht.

- Lösen Sie die vier Schrauben an der Vorderseite des Gehäuses und entfernen Sie die Vorderfront.
- Schließen Sie die Batteriekabel an: + (rot) wird rechts und - (schwarz) wird links angeschlossen (siehe Appendix A).
- Wenn die Batteriekabel des Phoenix Multi vertauscht sind (+ auf – und – auf +), wird die LED-Anzeige "reversed polarity" (vertauschte Polarität), gleich neben den Verbindungsschrauben, aufleuchten.
- Wenn die LED-Anzeige "reversed polarity" brennt, lösen Sie die Batteriekabel wieder und schließen sie auf die richtige Weise an.
- Nachdem das mitgelieferte Befestigungsmaterial angebracht ist, ziehen Sie die Anschlüsse fest an.
- Nehmen Sie nun die Autosicherung "mega fuse" aus der Verpackung, stecken Sie sie auf Position F4 und ziehen Sie sie, nachdem das mitgelieferte Befestigungsmaterial angebracht ist, fest.
- Ziehen Sie die Muttern fest an, um den Übergangswiderstand zu weit wie möglich zu reduzieren.

1.5 AC-Kabel anschließen



Aus Sicherheitsgründen muss das Gehäuse des Phoenix Multi geerdet werden. Zu diesem Zweck wurde auf der Unterseite des Gehäuses eine Erdungsschraube angebracht.

Der Klemmenblock befindet sich auf der Leiterplatte (siehe Appendix A). Der Landstrom- oder Netzanschluss muss mit einem dreidradigen Kabel an dem Phoenix Multi angeschlossen werden. Benutzen Sie ein dreidradiges Kabel mit einer weichen Ader und einem Querschnitt von 2,5 oder 4 mm² (Typ H05RN-F).

Vorgehensweise

Gehen Sie beim Anschließen der AC-Kabel wie folgt vor:

- Die AC-Komponente kann direkt an den Klemmenblock mit der Beschriftung "AC-out" angeschlossen werden, und zwar mit einem dreidradigen Kabel. Die Anschlussstellen sind deutlich markiert. Von links nach rechts: "PE" (Erde), "N" (Nullleiter) und "L" (Phase).
- Die AC-Netzspannung kann an den Klemmenblock mit der Aufschrift "AC-in" angeschlossen werden. Die Anschlussstellen sind deutlich markiert. "PE" (Erde), "N" (Nullleiter) und "L" (Phase).

1.6 Anschlussmöglichkeiten

Neben den Standardanschlüssen, können auch andere Geräte angeschlossen werden.

1.6.1 Starterbatterie

Der Phoenix Multi ist mit einem Anschluss zum Laden von Starterbatterien ausgestattet. Zum Anschließen siehe Appendix A.

1.6.2 Spannungsfühler (Multi/ MultiPlus)

Zur Kompensierung eventueller Kabelverluste während des Ladevorgangs können zwei "Fühler"-Drähte angeschlossen werden. Verwenden Sie einen Draht von mindestens 0,75mm². Zum Anschließen siehe Appendix A.

1.6.3 Temperaturfühler (Multi/ MultiPlus)

Zum Laden mit Temperaturangleichung kann der mitgelieferte Temperaturfühler angeschlossen werden (siehe Appendix A). Dieser Fühler ist isoliert und muss an den Minuspol der Batteries montiert werden.

GB

NL

F

D

Appendix

1.6.4 Fernbedienung

Der Phoenix Multi lässt sich auf zwei Arten aus Entfernung bedienen:

- einzig mit einem externen Schalter oder
- mit einer Fernbedienungstafel.

Zum Anschließen des Schalters siehe Appendix A.

Wenn Sie nur den externen Schalter benutzen, sollten Sie das Folgende berücksichtigen:

- Diese Funktionsweise ist nur möglich, wenn der Schalter am Phoenix Multi auf "on" steht,
- er darf nicht angeschlossen werden, wenn bereits eine Fernbedienungstafel angeschlossen ist.

Zum Anschließen der Fernbedienungstafel siehe Appendix A.

Wenn Sie eine Fernbedienungstafel benutzen, sollten Sie folgendes berücksichtigen:

- Diese Funktionsweise ist nur möglich, wenn der Schalter am Phoenix Multi auf "on" steht,

1.6.5 Externes Relais (Multi/ MultiPlus)

Wenn Sie mehr als 16 Ampeere durchschalten möchten, kann ein externes Relais verwendet werden. Wenden Sie sich hierfür an Ihren Lieferanten.

1.6.6 Parallelschaltung

Der Phoenix Multi kann mit mehreren Geräten des gleichen Typs parallel geschaltet werden (siehe Appendix G). Die Batterien müssen gemäß Appendix E oder F angeschlossen werden. Parallelschalten ist eine einfache Möglichkeit, um die Leistungskapazität zu erhöhen. Dabei verbinden Sie die einzelnen Geräten mit einem Spezialkabel. Das Kabel ist mit Schaltschema bei Victron Energy erhältlich.

Für eine Parallelschaltung gelten folgende Voraussetzungen:

- es dürfen nicht mehr als 5 Geräte parallel geschaltet werden;
- schalten Sie nur Geräte des gleichen Typs parallel;
- sorgen Sie für ausreichende Batteriekapazität;
- die vorgeschriebenen Kabelstärken (zwischen Batterie und Verteiler) müssen mit der Anzahl der parallel geschalteten Geräte multipliziert werden;
- stellen Sie die Multis nahe beieinander auf, jedoch mit genügend Platz für die Ventilation, ungefähr 10 cm.
- Temperaturfühler, Spannungsfühler und Fernbedienung müssen an das Stammgerät ("Master") angeschlossen werden;
- für jedes Gerät müssen gleich lange Kabel verwendet werden (AC und DC).

1.6.7 Dreiphasenschaltung^{MultiPlus}

Der Phoenix MultiPlus kann auch in einem Dreiphasennetz eingesetzt werden (siehe Appendix 0). Die Batterien müssen gemäß Appendix E oder F angeschlossen werden. Bei einer Dreiphasenschaltung müssen folgende Voraussetzungen erfüllt sein:

- es dürfen nur Geräte des gleichen Typs verbunden werden;
- sorgen Sie für ausreichende Batteriekapazität;
- stellen Sie die MultiPlus-Geräte nahe beieinander auf, jedoch mit genügend Platz für die Luftzirkulation;
- Temperaturfühler und Spannungsfühler sollten vorzugsweise an alle drei Geräte angeschlossen werden;
- mit Hilfe von Verteilern kann eine (einzige) Fernbedienung angeschlossen werden.

2. EINSTELLUNGEN



- Die Einstellungen dürfen nur von einem qualifizierten Elektrotechniker geändert werden.
- Lesen Sie vor eventuellen Änderungen erst die Anweisungen.
- Beim Einstellen des Ladegeräts müssen alle Verbindungen zur Batterie vom PhoenixMulti abgekoppelt sein.
- Verwenden Sie wiederaufladbare Batterien.
- Dieser Phoenix Multi ist ab Fabrik auf das Laden von Sonnenschein Dryfit A200 Gel-Batterien eingestellt. Für die empfohlene Batteriekapazität siehe Appendix 0.
- Die Batterien müssen während des Ladevorgangs in einem trockenen, gut ventilerten Raum stehen.

GB

NL

F

D

Appendix

2.1 Allgemeine Einstellungen

Die Einstellungen werden über Druckschalter und DIP-Schalter geändert (siehe Appendix A).

Über die DIP-Schalter aktivieren Sie den Setup und bestimmen Sie, welche Einstellung geändert wird. Mit den Druckschaltern können Sie den Wert dieser Einstellung ändern. Den eingestellten Wert lesen Sie auf den LED-Anzeigen ab. Paragraaf 0 und 0 beschreiben, wie die LED-Anzeigen abgelesen werden.

2.1.1 Standardeinstellungen ab Fabrik

Um alle Werkseinstellungen wieder herzustellen, müssen beide Druckschalter während des Setups 3 Sekunden lang eingedrückt werden.

Setup aktivieren

DS-8 on DS-7 DS-6 DS-5 DS-4 DS-3 DS-2 DS-1	DS-8 DS-7 DS-6 DS-5 DS-4 DS-3 DS-2 DS-1	DS-8 off DS-7 DS-6 DS-5 DS-4 DS-3 DS-2 DS-1	DS-8 off DS-7 DS-6 DS-5 DS-4 DS-3 DS-2 DS-1
Setup aktivieren: DS8 auf on	Einstellung wählen: mit DS3 bis DS7 stellen Sie den neuen Wert mittels der Druckschalter ein.	Setup aufschlagen durch DS3-DS7 zu verändern	Setup beenden: DS8 auf off.

DS-1 und DS-2 sind reserviert und müssen auf "Off" gestellt werden.

ACHTUNG: Der neue Wert wird nur gespeichert, wenn eine andere Einstellung selektiert ist. Wenn Sie den Setup beenden, ohne eine andere Einstellung gewählt zu haben, wird der neue Wert NICHT gespeichert. Änderungen, die nicht durchgeführt werden sollten, können Sie auf diese Weise rückgängig machen.

2.1.2 Ablesen LEDs mehrfache Auswahl (Multi/ MultiPlus)

Anhand der folgenden Formel kann der Wert einer Einstellung bestimmt werden:

$$\text{Eingestellter Wert} = \text{Einstellzahl} * \text{Skala} + \text{offset}$$

Der "offset" und die "Skala" werden pro Einstellung angegeben.

Die Einstellzahl wird anhand der LEDs wie folgt wiedergegeben:

- die LEDs sind in 2 Reihen von 4 LEDs unterteilt;
- jede Reihe zeigt die Ziffern 0-9 auf;
- gemeinsam ergeben diese Reihen eine Zahl mit 2 Ziffern;
- die linke Reihe gibt die linke Zahl, die rechte Reihe die rechte Zahl;
- die Ziffer einer Reihe bestimmen Sie, indem Sie die einzelnen "LED-Werte" zusammenzählen;
- eine blinkende LED zählt als 1, eine leuchtende LED als 2;
- 4 blinkende LED-Anzeigen sind ein Sonderfall, dies bedeutet eine 9.

Symbol	Bedeutung	LED-Wert
○	LED aus	0
☀	LED blinkt	1
●	LED leuchtet	2
☀ ☀ ☀ ☀	Alle LEDs einer Reihe blinken	9

Beispiele Einstellzahl:

<table style="border-collapse: collapse; text-align: center;"> <tr><td>○</td><td>0</td><td>○</td><td>0</td></tr> <tr><td>○</td><td>0</td><td>●</td><td>2</td></tr> <tr><td>○</td><td>0</td><td>●</td><td>2</td></tr> <tr><td>○</td><td>0</td><td>●</td><td>2</td></tr> <tr><td colspan="2" style="border-top: 1px solid black;">0</td><td colspan="2" style="border-top: 1px solid black;">6</td></tr> </table>	○	0	○	0	○	0	●	2	○	0	●	2	○	0	●	2	0		6		=6	<table style="border-collapse: collapse; text-align: center;"> <tr><td>○</td><td>0</td><td>☀</td><td>1</td></tr> <tr><td>○</td><td>0</td><td>●</td><td>2</td></tr> <tr><td>●</td><td>2</td><td>●</td><td>2</td></tr> <tr><td>●</td><td>2</td><td>●</td><td>2</td></tr> <tr><td colspan="2" style="border-top: 1px solid black;">4</td><td colspan="2" style="border-top: 1px solid black;">7</td></tr> </table>	○	0	☀	1	○	0	●	2	●	2	●	2	●	2	●	2	4		7		=47	<table style="border-collapse: collapse; text-align: center;"> <tr><td>○</td><td>0</td><td>☀</td><td></td></tr> <tr><td>○</td><td>0</td><td>☀</td><td></td></tr> <tr><td>☀</td><td>1</td><td>☀</td><td></td></tr> <tr><td>●</td><td>2</td><td>☀</td><td></td></tr> <tr><td colspan="2" style="border-top: 1px solid black;">3</td><td colspan="2" style="border-top: 1px solid black;">9</td></tr> </table>	○	0	☀		○	0	☀		☀	1	☀		●	2	☀		3		9		=39
○	0	○	0																																																														
○	0	●	2																																																														
○	0	●	2																																																														
○	0	●	2																																																														
0		6																																																															
○	0	☀	1																																																														
○	0	●	2																																																														
●	2	●	2																																																														
●	2	●	2																																																														
4		7																																																															
○	0	☀																																																															
○	0	☀																																																															
☀	1	☀																																																															
●	2	☀																																																															
3		9																																																															

Die Schrittgröße kann kleiner sein als der ablesbare Wert (Skalenwert). In diesem Fall muss die Drucktaste mehrere Male eingedrückt werden, bevor sich etwas auf der LED-Anzeige ändert.

2.1.3 Ablesen LEDs Entscheidungsauswahl/ zweierlei Auswahl (Multi/ MultiPlus)

Neben der Möglichkeit einen Wert einzustellen, die mehrfache Auswahl, besteht auch die Möglichkeit einer Entscheidungsauswahl/ zweifachen Auswahl. Hiermit kann eine bestimmte Einstellung an/ aus geschaltet bzw. aktiviert/ deaktiviert werden. Bei einer Entscheidungsauswahl gibt die linke Reihe Möglichkeit A an und die rechte Reihe Möglichkeit B.

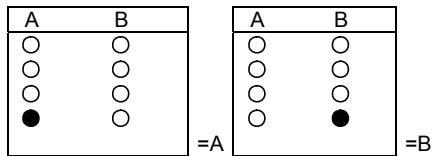

Die Standardeinstellung ab Werk ist immer A.
Bei jedem Einstellwert ist angegeben wofür A und B steht.

2.1.4 Default settings

Systemfrequenz	50 Hz
Umformerspannung	230 Vac
Lader an/ aus	an
Ladecharakteristik	adaptiven mith batterieschutzmodus
Ladestrom	75% von die maximaler Ladestrom
Vorab eingestellte Batterie Type	type 1
Absorptionsspannung	14.4/ 28.8/ 57.6 Vdc
Absorptionszeit/ maximale Absorptionszeit	4 Stunden
Ladeerhaltungsspannung	13.8/ 27.6/ 55.2 Vdc
Wiederholte Absorptionszeit	1 Stunde
Wiederholte Absorptionsintervall	7 tagen
Konstantstromsicherung an/ aus	an
Mains Waveform Check	an
Generator/ Landestrom	16 A
Generator/ Land-Unterstützung	aus
Dreiphaseneinstellung	aus
Leader/ Follower	follower

2.2 Systemfrequenz

Der Multi kann sowohl mit 50 Hz wie auch mit 60 Hz betrieben werden.

Stellen Sie DS 3-7 ein	Stellen Sie die Frequenz ein	Beispiel										
DS-8 <input type="checkbox"/> DS-7 <input type="checkbox"/> off DS-6 <input type="checkbox"/> off DS-5 <input checked="" type="checkbox"/> on DS-4 <input type="checkbox"/> off DS-3 <input type="checkbox"/> off DS-2 <input type="checkbox"/> DS-1 <input type="checkbox"/>	Bestimmen Sie die gewünschte Frequenz. Die Standardeinstellung ist 50 Hz. Die linke LED-Reihe steht für 50 Hz, die rechte LED-Reihe für 60 Hz. Drücken Sie so lange auf den Druckschalter, bis die gewünschte LED-Anzeige erscheint.	Gewünscht: Frequenz ist 60 Hz. LED-Anzeige = <table border="1" style="display: inline-table; vertical-align: middle;"> <tr> <td>50Hz</td> <td>60Hz</td> </tr> <tr> <td><input type="checkbox"/></td> <td><input type="checkbox"/></td> </tr> <tr> <td><input type="checkbox"/></td> <td><input type="checkbox"/></td> </tr> <tr> <td><input type="checkbox"/></td> <td><input type="checkbox"/></td> </tr> <tr> <td><input type="checkbox"/></td> <td><input checked="" type="checkbox"/></td> </tr> </table>	50Hz	60Hz	<input type="checkbox"/>	<input type="checkbox"/>	<input type="checkbox"/>	<input type="checkbox"/>	<input type="checkbox"/>	<input type="checkbox"/>	<input type="checkbox"/>	<input checked="" type="checkbox"/>
50Hz	60Hz											
<input type="checkbox"/>	<input type="checkbox"/>											
<input type="checkbox"/>	<input type="checkbox"/>											
<input type="checkbox"/>	<input type="checkbox"/>											
<input type="checkbox"/>	<input checked="" type="checkbox"/>											

2.3 Einstellung Umformer

Umformerspannung

Die Umformerspannung kann von 180Vac - 245Vac eingestellt werden.

Stellen Sie DS 3-7 ein	Stellen Sie die Spannung ein	Beispiel																				
DS-8 <input type="checkbox"/> DS-7 <input checked="" type="checkbox"/> on DS-6 <input checked="" type="checkbox"/> on DS-5 <input type="checkbox"/> off DS-4 <input type="checkbox"/> off DS-3 <input type="checkbox"/> off DS-2 <input type="checkbox"/> DS-1 <input type="checkbox"/>	Bestimmen Sie die gewünschte Spannung V_q . Bestimmen Sie die Einstellzahl: $Skala=1V$ $offset=180V$ $Einstellzahl=(V_q-180)$ Bestimmen Sie die LED-Anzeige. Drücken Sie so lange auf den Druckschalter, bis die gewünschte LED-Anzeige erscheint.	Gewünscht: Spannung is 225V. Einstellzahl = $225-180 = 45$. LED-Anzeige = <table border="1" style="display: inline-table; vertical-align: middle;"> <tr> <td><input type="checkbox"/></td> <td>0</td> <td><input type="checkbox"/></td> <td>0</td> </tr> <tr> <td><input type="checkbox"/></td> <td>0</td> <td><input checked="" type="checkbox"/></td> <td>1</td> </tr> <tr> <td><input checked="" type="checkbox"/></td> <td>2</td> <td><input checked="" type="checkbox"/></td> <td>2</td> </tr> <tr> <td><input checked="" type="checkbox"/></td> <td>2</td> <td><input checked="" type="checkbox"/></td> <td>2</td> </tr> <tr> <td></td> <td>4</td> <td></td> <td>5</td> </tr> </table>	<input type="checkbox"/>	0	<input type="checkbox"/>	0	<input type="checkbox"/>	0	<input checked="" type="checkbox"/>	1	<input checked="" type="checkbox"/>	2	<input checked="" type="checkbox"/>	2	<input checked="" type="checkbox"/>	2	<input checked="" type="checkbox"/>	2		4		5
<input type="checkbox"/>	0	<input type="checkbox"/>	0																			
<input type="checkbox"/>	0	<input checked="" type="checkbox"/>	1																			
<input checked="" type="checkbox"/>	2	<input checked="" type="checkbox"/>	2																			
<input checked="" type="checkbox"/>	2	<input checked="" type="checkbox"/>	2																			
	4		5																			

Die Schrittgröße ist 1V.

ACHTUNG: für setzen die spannung von die Phoenix Umformer gebrauchen Sie ein spannungsmeter, weil die Phoenix Umformer allein 4 LEDs hast.

2.4 Einstellung Lader (Multi/ MultiPlus)

Beim Einstellen des Laders müssen alle Verbindungen zwischen Batterie und PhoenixMulti abgekoppelt sein.

Lader an/ aus

Auf Wunsch kann der Lader des Phoenix Multi auch ausgeschaltet werden.
Die Standardeinstellung ist "An".

Stellen Sie DS 3-7 ein	So schalten Sie den Lader an oder aus	Beispiel										
DS-8 <input type="checkbox"/> DS-7 <input type="checkbox"/> on DS-6 <input type="checkbox"/> off DS-5 <input type="checkbox"/> off DS-4 <input type="checkbox"/> on DS-3 <input type="checkbox"/> off DS-2 <input type="checkbox"/> DS-1 <input type="checkbox"/>	Bestimmen Sie, ob der Lader an- oder ausgeschaltet sein muss. Die Werkseinstellung ist "an". Die linke LED-Reihe steht für "an", die rechte LED-Reihe für "aus". Drücken Sie so lange auf den Druckschalter, bis die gewünschte LED-Anzeige erscheint.	Gewünscht: Lader ist aus. LED-Anzeige = <table border="1" style="margin-left: 20px;"> <thead> <tr> <th>An</th> <th>Aus</th> </tr> </thead> <tbody> <tr> <td><input type="checkbox"/></td> <td><input type="checkbox"/></td> </tr> <tr> <td><input type="checkbox"/></td> <td><input type="checkbox"/></td> </tr> <tr> <td><input type="checkbox"/></td> <td><input type="checkbox"/></td> </tr> <tr> <td><input type="checkbox"/></td> <td><input checked="" type="checkbox"/></td> </tr> </tbody> </table>	An	Aus	<input type="checkbox"/>	<input type="checkbox"/>	<input type="checkbox"/>	<input type="checkbox"/>	<input type="checkbox"/>	<input type="checkbox"/>	<input type="checkbox"/>	<input checked="" type="checkbox"/>
An	Aus											
<input type="checkbox"/>	<input type="checkbox"/>											
<input type="checkbox"/>	<input type="checkbox"/>											
<input type="checkbox"/>	<input type="checkbox"/>											
<input type="checkbox"/>	<input checked="" type="checkbox"/>											

Ladecharakteristik

Beim Phoenix Multi haben Sie die Auswahl aus 3 Ladecharakteristiken.

Die **Fixed Ladecharakteristik** bietet die Absorptionsspannung für eine bestimmte (fest einstellbare) Zeit. Nach der Absorptionsphase wird für eine bestimmte (wiederum fest einstellbare) Zeit die Ladeerhaltungsspannung angeboten, um danach, eine (meist kürzere) Zeit lang wieder die Absorptionsspannung anzubieten.

Bei der **Adaptiven Ladecharakteristik** ist der Zeitraum, in dem die Absorptionsspannung angeboten wird, von der Ladung abhängig, die während der Konstantstromphase "bulk" geliefert wurde. Danach folgt eine Ladeerhaltungsphase von 24 Stunden, nach der auf 13/26/ 52V (reduzierte Ladeerhaltung) zurückgeschaltet wird. Wie bei der Fixed Ladecharakteristik wird auch hier periodisch eine Absorptionsphase eingehalten.

Auch im **Batterieschutzmodus** wird die adaptive Ladecharakteristik benutzt, der Batterie wird dabei jedoch eine höhere Absorptionsspannung angeboten. Allerdings wird die Spannung nur immer sukzessive erhöht, wodurch die Batterie gegen Überladungsschäden geschützt wird.

Stellen Sie DS 3-7 ein	Stellen Sie die Ladecharakteristiken ein	Beispiel																								
DS-8 <input type="checkbox"/> DS-7 <input type="checkbox"/> off DS-6 <input type="checkbox"/> on DS-5 <input type="checkbox"/> on DS-4 <input type="checkbox"/> on DS-3 <input type="checkbox"/> off DS-2 <input type="checkbox"/> DS-1 <input type="checkbox"/>	Bestimmen Sie, welche Charakteristik Sie wünschen: 1: Fixed 2: Adaptiv 3: Adaptiv mit Batterieschutzmodus (default) Drücken Sie so lange auf den Druckschalter, bis die gewünschte LED-Anzeige erscheint.	Gewünscht: Ladecharakteristik ist "Fixed". Einstellzahl = 1. LED-Anzeige = <table border="1" style="margin-left: 20px;"> <tr><td><input type="radio"/></td><td>0</td><td><input type="radio"/></td><td>0</td></tr> <tr><td><input type="radio"/></td><td>0</td><td><input type="radio"/></td><td>0</td></tr> <tr><td><input type="radio"/></td><td>0</td><td><input type="radio"/></td><td>0</td></tr> <tr><td><input type="radio"/></td><td>0</td><td><input checked="" type="radio"/></td><td>1</td></tr> <tr><td colspan="2"><hr/></td><td colspan="2"><hr/></td></tr> <tr><td colspan="2">0</td><td colspan="2">1</td></tr> </table>	<input type="radio"/>	0	<input type="radio"/>	0	<input type="radio"/>	0	<input type="radio"/>	0	<input type="radio"/>	0	<input type="radio"/>	0	<input type="radio"/>	0	<input checked="" type="radio"/>	1	<hr/>		<hr/>		0		1	
<input type="radio"/>	0	<input type="radio"/>	0																							
<input type="radio"/>	0	<input type="radio"/>	0																							
<input type="radio"/>	0	<input type="radio"/>	0																							
<input type="radio"/>	0	<input checked="" type="radio"/>	1																							
<hr/>		<hr/>																								
0		1																								

Ladestrom

Der Ladestrom ist ab Werk auf "75% von die maximaler Ladestrom" eingestellt. Für die meisten Verwendungszwecke wird dieser Strom zu stark sein. Um die Batterien nicht zu beschädigen, muss der Ladestrom auf die 0,1-0,2-fache Batteriekapazität angepasst werden.

Stellen Sie DS 3-7 ein	Stellen Sie den Ladestrom ein	Beispiel																								
DS-8 <input type="checkbox"/> DS-7 <input type="checkbox"/> off DS-6 <input type="checkbox"/> on DS-5 <input type="checkbox"/> off DS-4 <input type="checkbox"/> off DS-3 <input type="checkbox"/> off DS-2 <input type="checkbox"/> DS-1 <input type="checkbox"/>	Bestimmen Sie den gewünschten Ladestrom I_q . Bestimmen Sie die Einstellzahl. $Skala = 2A$ $Offset = 0A$ $Einstellzahl = I_q/2$ Bestimmen Sie die LED-Anzeige. Drücken Sie so lange auf den Druckschalter, bis die gewünschte LED-Anzeige erscheint.	Batteriekapazität ist 450Ah. Der empfohlene Höchstwert des Ladestroms ist $450 \cdot 0,2 = 90A$. Einstellzahl = $90/2 = 45$. LED-Anzeige = <table border="1" style="margin-left: 20px;"> <tr><td><input type="radio"/></td><td>0</td><td><input type="radio"/></td><td>0</td></tr> <tr><td><input type="radio"/></td><td>0</td><td><input checked="" type="radio"/></td><td>1</td></tr> <tr><td><input checked="" type="radio"/></td><td>2</td><td><input checked="" type="radio"/></td><td>2</td></tr> <tr><td><input checked="" type="radio"/></td><td>2</td><td><input checked="" type="radio"/></td><td>2</td></tr> <tr><td colspan="2"><hr/></td><td colspan="2"><hr/></td></tr> <tr><td colspan="2">4</td><td colspan="2">5</td></tr> </table>	<input type="radio"/>	0	<input type="radio"/>	0	<input type="radio"/>	0	<input checked="" type="radio"/>	1	<input checked="" type="radio"/>	2	<input checked="" type="radio"/>	2	<input checked="" type="radio"/>	2	<input checked="" type="radio"/>	2	<hr/>		<hr/>		4		5	
<input type="radio"/>	0	<input type="radio"/>	0																							
<input type="radio"/>	0	<input checked="" type="radio"/>	1																							
<input checked="" type="radio"/>	2	<input checked="" type="radio"/>	2																							
<input checked="" type="radio"/>	2	<input checked="" type="radio"/>	2																							
<hr/>		<hr/>																								
4		5																								

Die Schrittgröße ist 1A.

Vorab eingestellte Batterietypen

Um die Absorptions- und Ladeerhaltungsspannung sowie die maximale Absorptionszeit einfacher einstellen zu können, wurden einige Batterietypen bereits vorab definiert:

	Batterietyp	Absorptionsspannung			Ladeerhaltungsspannung			Maximale Absorptionszeit
0	Benutzerdefiniert							
1	Sonnenschein Dryfit A200 Gel	14.4V	28.8V	57.6V	13.8V/ 13.2V	27.6V/ 26.4V	55.2V/ 52.8V	4 Stunden
2	Traktion	15.0V	30.0V	60.0V	13.8V/ 13.2V	27.6V/ 26.4V	55.2V/ 52.8V	6 Stunden
3	Semi-Traktion ¹	14.4V	28.8V	57.6V	14.0V/ 13.2V	28.0V/ 26.4V	56.0V/ 52.8V	5 Stunden
4	Victory ¹	14.8V	29.6V	59.2V	14.0V/ 13.2V	28.0V/ 26.4V	56.0V/ 52.8V	5 Stunden

¹Die optimale Absorptionsspannung der flachen Bleisäurebatterieplatten hängt von mechanischen und chemischen Eigenschaften ab. Batterien mit einem hohen Antimongehalt können im Allgemeinen mit einer niedrigeren Absorptionsspannung geladen werden als Batterien mit einem niedrigen Antimongehalt, wie z. B. die Victron Kohlenstofffaserbatterie. (Siehe auch das Buch "Elektrizität an Bord von Yachten" auf www.victronenergy.com)

Stellen Sie DS 3-7 ein	Stellen Sie den Batterietyp ein	Beispiel																				
DS-8 <input type="checkbox"/> DS-7 <input type="checkbox"/> on DS-6 <input type="checkbox"/> on DS-5 <input type="checkbox"/> off DS-4 <input type="checkbox"/> off DS-3 <input type="checkbox"/> on DS-2 <input type="checkbox"/> DS-1 <input type="checkbox"/>	Bestimmen Sie, welcher Batterietyp verwendet wird. Bestimmen Sie mittels der Tabelle die Einstellzahl. Drücken Sie auf die Tasten bis die gewünschte LED-Anzeige erscheint. ACHTUNG: 0 kann nicht gewählt werden, wird aber angezeigt, wenn die Absorptionsspannung, die Ladeerhaltungsspannung oder die Absorptionszeit geändert wird.	Gewünscht: Batterietyp ist Victory: Einstellzahl = 4. LED-Anzeige = <table border="1" style="margin-left: 20px;"> <tr> <td><input type="radio"/></td> <td>0</td> <td><input type="radio"/></td> <td>0</td> </tr> <tr> <td><input type="radio"/></td> <td>0</td> <td><input type="radio"/></td> <td>0</td> </tr> <tr> <td><input type="radio"/></td> <td>0</td> <td><input checked="" type="radio"/></td> <td>2</td> </tr> <tr> <td><input type="radio"/></td> <td>0</td> <td><input checked="" type="radio"/></td> <td>2</td> </tr> <tr> <td colspan="2" style="text-align: center;">0</td> <td colspan="2" style="text-align: center;">4</td> </tr> </table>	<input type="radio"/>	0	<input type="radio"/>	0	<input type="radio"/>	0	<input type="radio"/>	0	<input type="radio"/>	0	<input checked="" type="radio"/>	2	<input type="radio"/>	0	<input checked="" type="radio"/>	2	0		4	
<input type="radio"/>	0	<input type="radio"/>	0																			
<input type="radio"/>	0	<input type="radio"/>	0																			
<input type="radio"/>	0	<input checked="" type="radio"/>	2																			
<input type="radio"/>	0	<input checked="" type="radio"/>	2																			
0		4																				

Der Lader ist ab Werk eingestellt für das Laden von Gel- Batterien, wie die Sonnenschein Dryfit A200 Batterien.

Wenn andere Batterietypen verwendet werden, fragen Sie Ihren Batterielieferanten nach der richtigen Ladespannung und lassen Sie, wenn erforderlich, den Phoenix Multi entsprechend anpassen.

Absorptionsspannung

Die Absorptionsspannung kann von 12-16/ 24-32/ 48-64V eingestellt werden. Beim Einstellen müssen die Batterie, der Temperaturfühler und der Spannungsfühler abgekoppelt sein.

Stellen Sie DS 3-7 ein	Stellen Sie die Absorptionsspannung ein	Beispiel																				
DS-8 <input type="checkbox"/> DS-7 <input type="checkbox"/> off DS-6 <input type="checkbox"/> off DS-5 <input type="checkbox"/> off DS-4 <input type="checkbox"/> off DS-3 <input type="checkbox"/> off DS-2 <input type="checkbox"/> DS-1 <input type="checkbox"/>	Bestimmen Sie die gewünschte Absorptionsspannung V_q . Bestimmen Sie die Einstellzahl. $Skala = 0,1V$ $Offset = 12/24V$ $Einstellzahl = (V_q - 24)/0,1$ Bestimmen Sie die LED-Anzeige. Drücken Sie so lange auf den Druckschalter, bis die gewünschte LED-Anzeige erscheint.	Gewünscht: Absorptionsspannung ist 28,5V. $Einstellzahl = (28,5 - 24)/0,1 = 45$. LED-Anzeige = <table border="1" style="margin-left: 20px;"> <tr> <td><input type="checkbox"/></td><td>0</td><td><input type="checkbox"/></td><td>0</td> </tr> <tr> <td><input type="checkbox"/></td><td>0</td><td><input checked="" type="checkbox"/></td><td>1</td> </tr> <tr> <td><input checked="" type="checkbox"/></td><td>2</td><td><input checked="" type="checkbox"/></td><td>2</td> </tr> <tr> <td><input checked="" type="checkbox"/></td><td>2</td><td><input checked="" type="checkbox"/></td><td>2</td> </tr> <tr> <td></td><td><u>4</u></td><td></td><td><u>5</u></td> </tr> </table>	<input type="checkbox"/>	0	<input type="checkbox"/>	0	<input type="checkbox"/>	0	<input checked="" type="checkbox"/>	1	<input checked="" type="checkbox"/>	2	<input checked="" type="checkbox"/>	2	<input checked="" type="checkbox"/>	2	<input checked="" type="checkbox"/>	2		<u>4</u>		<u>5</u>
<input type="checkbox"/>	0	<input type="checkbox"/>	0																			
<input type="checkbox"/>	0	<input checked="" type="checkbox"/>	1																			
<input checked="" type="checkbox"/>	2	<input checked="" type="checkbox"/>	2																			
<input checked="" type="checkbox"/>	2	<input checked="" type="checkbox"/>	2																			
	<u>4</u>		<u>5</u>																			

Die Schrittgröße ist 0,05 V.

Absorptionszeit/ maximale Absorptionszeit

In der Fixed Ladecharakteristik bestimmt diese Einstellung wie lange der Lader die Absorptionsspannung anbietet. In der adaptiven Ladecharakteristik bestimmt diese Einstellung die maximale Zeit, in der der Lader die Absorptionsspannung anbietet. Die (maximale) Absorptionszeit kann von 1 bis 8 Stunden eingestellt werden.

Stellen Sie DS 3-7 ein	Stellen Sie die maximale Absorptionszeit ein	Beispiel																				
DS-8 <input type="checkbox"/> DS-7 <input type="checkbox"/> on DS-6 <input type="checkbox"/> off DS-5 <input type="checkbox"/> on DS-4 <input type="checkbox"/> on DS-3 <input type="checkbox"/> off DS-2 <input type="checkbox"/> DS-1 <input type="checkbox"/>	Bestimmen Sie die gewünschte (maximale) Absorptionszeit T_q . Bestimmen Sie die Einstellzahl. $Skala = 1\ Stunde$ $Offset = 0$ $Einstellzahl = T_q$ Bestimmen Sie die LED-Anzeige. Drücken Sie so lange auf den Druckschalter, bis die gewünschte LED-Anzeige erscheint.	Gewünscht: (maximale) Absorptionszeit ist 4 Stunden. Einstellzahl = 4. LED-Anzeige = <table border="1" style="margin-left: 20px;"> <tr> <td><input type="checkbox"/></td><td>0</td><td><input type="checkbox"/></td><td>0</td> </tr> <tr> <td><input type="checkbox"/></td><td>0</td><td><input type="checkbox"/></td><td>0</td> </tr> <tr> <td><input type="checkbox"/></td><td>0</td><td><input checked="" type="checkbox"/></td><td>2</td> </tr> <tr> <td><input type="checkbox"/></td><td>0</td><td><input checked="" type="checkbox"/></td><td>2</td> </tr> <tr> <td></td><td><u>0</u></td><td></td><td><u>4</u></td> </tr> </table>	<input type="checkbox"/>	0	<input type="checkbox"/>	0	<input type="checkbox"/>	0	<input type="checkbox"/>	0	<input type="checkbox"/>	0	<input checked="" type="checkbox"/>	2	<input type="checkbox"/>	0	<input checked="" type="checkbox"/>	2		<u>0</u>		<u>4</u>
<input type="checkbox"/>	0	<input type="checkbox"/>	0																			
<input type="checkbox"/>	0	<input type="checkbox"/>	0																			
<input type="checkbox"/>	0	<input checked="" type="checkbox"/>	2																			
<input type="checkbox"/>	0	<input checked="" type="checkbox"/>	2																			
	<u>0</u>		<u>4</u>																			

Die Schrittgröße ist 1 Stunde.

Ladeerhaltungsspannung

Die Ladeerhaltungsspannung kann auf 12-16/ 24-32/ 48-64V eingestellt werden. Beim Einstellen müssen die Batterie, der Temperaturfühler und der Spannungsfühler abgekoppelt sein.

GB

NL

F

D

Appendix

Stellen Sie DS 3-7 ein	Stellen Sie die Ladeerhaltungsspannung ein	Beispiel																								
DS-8 <input type="checkbox"/> DS-7 <input checked="" type="checkbox"/> on DS-6 <input type="checkbox"/> off DS-5 <input type="checkbox"/> off DS-4 <input type="checkbox"/> off DS-3 <input type="checkbox"/> off DS-2 <input type="checkbox"/> DS-1 <input type="checkbox"/>	Bestimmen Sie die gewünschte Ladeerhaltungsspannung V_q . Bestimmen Sie die Einstellzahl. $Skala = 0,1V$ $Minimum = 12/24V$ $Einstellzahl = (V_q - 24)/0,1$ Bestimmen Sie die LED-Anzeige. Drücken Sie so lange auf den Druckschalter, bis die gewünschte LED-Anzeige erscheint.	Gewünscht: Ladeerhaltungsspannung ist 28,5V. $Einstellzahl = (28,5 - 24)/0,1 = 45$. LED-Anzeige = <table border="1" style="margin-left: 20px;"> <tr><td><input type="radio"/></td><td>0</td><td><input type="radio"/></td><td>0</td></tr> <tr><td><input type="radio"/></td><td>0</td><td><input checked="" type="radio"/></td><td>1</td></tr> <tr><td><input checked="" type="radio"/></td><td>2</td><td><input checked="" type="radio"/></td><td>2</td></tr> <tr><td><input checked="" type="radio"/></td><td>2</td><td><input checked="" type="radio"/></td><td>2</td></tr> <tr><td colspan="2"><hr/></td><td colspan="2"><hr/></td></tr> <tr><td colspan="2">4</td><td colspan="2">5</td></tr> </table>	<input type="radio"/>	0	<input type="radio"/>	0	<input type="radio"/>	0	<input checked="" type="radio"/>	1	<input checked="" type="radio"/>	2	<input checked="" type="radio"/>	2	<input checked="" type="radio"/>	2	<input checked="" type="radio"/>	2	<hr/>		<hr/>		4		5	
<input type="radio"/>	0	<input type="radio"/>	0																							
<input type="radio"/>	0	<input checked="" type="radio"/>	1																							
<input checked="" type="radio"/>	2	<input checked="" type="radio"/>	2																							
<input checked="" type="radio"/>	2	<input checked="" type="radio"/>	2																							
<hr/>		<hr/>																								
4		5																								

Die Schrittgröße ist 0,05 V.

Wiederholte Absorption

Nach jedem Ladezyklus wird der Lader im Anschluss an die Ladeerhaltungsphase nach einem vorher eingestellten Zeitraum auf die hohe Ladespannung zurückschalten. Dieses Zurückschalten nennt man "wiederholte Absorptionsphase" (siehe Appendix C).

Wiederholte Absorptionszeit

Die wiederholte Absorptionszeit kann von 1 bis 72 Viertelstunden eingestellt werden.

Stellen Sie DS 3-7 ein	Stellen Sie die wiederholte Absorptionszeit ein	Beispiel																								
DS-8 <input type="checkbox"/> DS-7 <input checked="" type="checkbox"/> on DS-6 <input checked="" type="checkbox"/> on DS-5 <input checked="" type="checkbox"/> on DS-4 <input type="checkbox"/> off DS-3 <input type="checkbox"/> off DS-2 <input type="checkbox"/> DS-1 <input type="checkbox"/>	Bestimmen Sie die wiederholte Absorptionszeit T_q in Viertelstunden. Bestimmen Sie die Einstellzahl. $Skala = 1 \text{ Viertelstunde}$ $Offset = 0$ $Einstellzahl = T_q$ Bestimmen Sie die LED-Anzeige. Drücken Sie so lange auf den Druckschalter, bis die gewünschte LED-Anzeige erscheint.	Gewünscht: wiederholte Absorptionszeit ist 1 Stunde. $Einstellzahl = 1 \text{ Stunde} = 4$ Viertelstunden LED-Anzeige = <table border="1" style="margin-left: 20px;"> <tr><td><input type="radio"/></td><td>0</td><td><input type="radio"/></td><td>0</td></tr> <tr><td><input type="radio"/></td><td>0</td><td><input type="radio"/></td><td>0</td></tr> <tr><td><input type="radio"/></td><td>0</td><td><input checked="" type="radio"/></td><td>2</td></tr> <tr><td><input type="radio"/></td><td>0</td><td><input checked="" type="radio"/></td><td>2</td></tr> <tr><td colspan="2"><hr/></td><td colspan="2"><hr/></td></tr> <tr><td colspan="2">0</td><td colspan="2">4</td></tr> </table>	<input type="radio"/>	0	<input type="radio"/>	0	<input type="radio"/>	0	<input type="radio"/>	0	<input type="radio"/>	0	<input checked="" type="radio"/>	2	<input type="radio"/>	0	<input checked="" type="radio"/>	2	<hr/>		<hr/>		0		4	
<input type="radio"/>	0	<input type="radio"/>	0																							
<input type="radio"/>	0	<input type="radio"/>	0																							
<input type="radio"/>	0	<input checked="" type="radio"/>	2																							
<input type="radio"/>	0	<input checked="" type="radio"/>	2																							
<hr/>		<hr/>																								
0		4																								

Die Schrittgröße ist 1 Viertelstunde.

Wiederholter Absorptionsintervall

Der wiederholte Absorptionsintervall, auch "reduced float" oder reduzierte Ladeerhaltung genannt, kann von 1 bis 45 Tage eingestellt werden.

Stellen Sie DS 3-7 ein	Stellen Sie den wiederholten Absorptionsintervall (reduced float) ein	Beispiel																								
DS-8 <input type="text"/> DS-7 <input type="text" value="off"/> DS-6 <input type="text" value="off"/> DS-5 <input type="text" value="off"/> DS-4 <input type="text" value="on"/> DS-3 <input type="text" value="off"/> DS-2 <input type="text"/> DS-1 <input type="text"/>	Bestimmen Sie die gewünschte Intervallzeit für reduzierte Ladeerhaltung. Bestimmen Sie die Einstellzahl. <i>Skala = 1 Tag</i> <i>Offset = 0</i> <i>Einstellzahl = Tq</i> Bestimmen Sie die LED-Anzeige. Drücken Sie so lange auf den Druckschalter, bis die gewünschte LED-Anzeige erscheint.	Gewünscht: Reduzierte Ladeerhaltungszeit ist 1 Woche. Einstellzahl = 7. LED-Anzeige = <table border="1" data-bbox="922 461 1139 595"> <tr> <td><input type="radio"/></td> <td>0</td> <td><input type="radio"/></td> <td>1</td> </tr> <tr> <td><input type="radio"/></td> <td>0</td> <td><input checked="" type="radio"/></td> <td>2</td> </tr> <tr> <td><input type="radio"/></td> <td>0</td> <td><input checked="" type="radio"/></td> <td>2</td> </tr> <tr> <td><input type="radio"/></td> <td>0</td> <td><input checked="" type="radio"/></td> <td>2</td> </tr> <tr> <td colspan="2"><hr/></td> <td colspan="2"><hr/></td> </tr> <tr> <td></td> <td>0</td> <td></td> <td>7</td> </tr> </table>	<input type="radio"/>	0	<input type="radio"/>	1	<input type="radio"/>	0	<input checked="" type="radio"/>	2	<input type="radio"/>	0	<input checked="" type="radio"/>	2	<input type="radio"/>	0	<input checked="" type="radio"/>	2	<hr/>		<hr/>			0		7
<input type="radio"/>	0	<input type="radio"/>	1																							
<input type="radio"/>	0	<input checked="" type="radio"/>	2																							
<input type="radio"/>	0	<input checked="" type="radio"/>	2																							
<input type="radio"/>	0	<input checked="" type="radio"/>	2																							
<hr/>		<hr/>																								
	0		7																							

Die Schrittgröße ist 1 Tag.

2.5 Besondere Einstellungen

Konstantstromsicherung an/ aus

Wenn der Lader nach 10 Stunden Aufladen in der Konstantspannungsphase die Absorptionsspannung noch nicht erreicht hat, kann es sein, dass die Batterie beschädigt ist. Um weitere Schäden zu verhindern, wird der Lader nach 10 Stunden Konstantspannung "bulk" automatisch ausgeschaltet. In diesem Falle blinkt die LED-Anzeige "bulk". Diese Sicherung kann auch ausgeschaltet werden.

Stellen Sie DS 3-7 ein	Stellen Sie die Konstantstromsicherung auf "an" oder "aus"	Beispiel										
DS-8 <input type="checkbox"/> DS-7 <input type="checkbox"/> off DS-6 <input type="checkbox"/> on DS-5 <input type="checkbox"/> off DS-4 <input type="checkbox"/> on DS-3 <input type="checkbox"/> off DS-2 <input type="checkbox"/> DS-1 <input type="checkbox"/>	Bestimmen Sie, ob die Sicherung für Konstantspannung ein oder ausgeschaltet sein soll. Die Werkseinstellung ist "an". Die linke LED-Reihe steht für "an", die rechte LED-Reihe für "aus". Drücken Sie so lange auf den Druckschalter, bis die gewünschte LED-Anzeige erscheint.	Gewünscht: Konstantstromsicherung ist aus. LED-Anzeige = <table border="1" style="margin-left: 20px;"> <thead> <tr> <th>An</th> <th>Aus</th> </tr> </thead> <tbody> <tr><td><input type="checkbox"/></td><td><input type="checkbox"/></td></tr> <tr><td><input type="checkbox"/></td><td><input type="checkbox"/></td></tr> <tr><td><input type="checkbox"/></td><td><input type="checkbox"/></td></tr> <tr><td><input type="checkbox"/></td><td><input checked="" type="checkbox"/></td></tr> </tbody> </table>	An	Aus	<input type="checkbox"/>	<input type="checkbox"/>	<input type="checkbox"/>	<input type="checkbox"/>	<input type="checkbox"/>	<input type="checkbox"/>	<input type="checkbox"/>	<input checked="" type="checkbox"/>
An	Aus											
<input type="checkbox"/>	<input type="checkbox"/>											
<input type="checkbox"/>	<input type="checkbox"/>											
<input type="checkbox"/>	<input type="checkbox"/>											
<input type="checkbox"/>	<input checked="" type="checkbox"/>											

Mains Waveform Check

Die Phoenix Multi checks oder die main Spannung hast nicht allein die korrekt Spannung, aber auch die korrekt Form. Wie die Phoenix Multi nicht gut functionieren auf ein generator diese function kunne werden ausgeschalt.

Stellen Sie DS 3-7 ein	Stellen Sie die Mains Voltage Check auf "an" oder "aus"	Beispiel										
DS-8 <input type="checkbox"/> DS-7 <input type="checkbox"/> off DS-6 <input type="checkbox"/> on DS-5 <input type="checkbox"/> off DS-4 <input type="checkbox"/> off DS-3 <input type="checkbox"/> on DS-2 <input type="checkbox"/> DS-1 <input type="checkbox"/>	Bestimmen Sie, ob die Mains Waveform Check ein oder ausgeschaltet sein soll. Die Werkseinstellung ist "an". Die linke LED-Reihe steht für "an". Die rechte LED-Reihe steht für "an". Drücken Sie so lange auf den Druckschalter, bis die gewünschte LED-Anzeige erscheint.	Gewünscht: Mains Waveform Check ist aus. LED-Anzeige = <table border="1" style="margin-left: 20px;"> <thead> <tr> <th>An</th> <th>Aus</th> </tr> </thead> <tbody> <tr><td><input type="checkbox"/></td><td><input type="checkbox"/></td></tr> <tr><td><input type="checkbox"/></td><td><input type="checkbox"/></td></tr> <tr><td><input type="checkbox"/></td><td><input type="checkbox"/></td></tr> <tr><td><input type="checkbox"/></td><td><input checked="" type="checkbox"/></td></tr> </tbody> </table>	An	Aus	<input type="checkbox"/>	<input type="checkbox"/>	<input type="checkbox"/>	<input type="checkbox"/>	<input type="checkbox"/>	<input type="checkbox"/>	<input type="checkbox"/>	<input checked="" type="checkbox"/>
An	Aus											
<input type="checkbox"/>	<input type="checkbox"/>											
<input type="checkbox"/>	<input type="checkbox"/>											
<input type="checkbox"/>	<input type="checkbox"/>											
<input type="checkbox"/>	<input checked="" type="checkbox"/>											

Generator/ Landstrom

Um den Generator oder den Landstromanschluss abzusichern, wird der Ladestrom so eingestellt, dass das die vom Lader und der AC-Verbrauchergruppe abgenommene Gesamtleistung die eingestellte Stromleistung nicht übersteigt. Wenn der AC-Verbrauch die eingestellte Stromleistung überschreitet, wird sich der Lader ausschalten und die LED-Anzeige "mains on" wird blinken. Es kann jetzt passieren, dass die Landsicherung durchbrennt oder der Generator sich wegen Überbelastung ausschaltet. In einem solchen Fall wird der Multi versuchen, auf Umformerbetrieb umzuschalten. Der Generator/ Landstrom kann von 1 bis 16A eingestellt werden.

Stellen Sie DS 3-7 ein	Stellen Sie den Landstrom ein	Beispiel																				
DS-8 <input type="checkbox"/> DS-7 <input type="checkbox"/> off DS-6 <input checked="" type="checkbox"/> on DS-5 <input checked="" type="checkbox"/> on DS-4 <input type="checkbox"/> off DS-3 <input type="checkbox"/> off DS-2 <input type="checkbox"/> DS-1 <input type="checkbox"/>	Bestimmen Sie die gewünschte Landstrombegrenzung I_q . Bestimmen Sie die Einstellzahl. $Skala = 1A$ $Offset = 0$ $Einstellzahl = (I_q)/1$ Bestimmen Sie die LED-Anzeige. Drücken Sie so lange auf den Druckschalter, bis die gewünschte LED-Anzeige erscheint.	Gewünscht: Landstrombegrenzung ist 16A. Einstellzahl = 16. LED-Anzeige = <table border="1" style="margin-left: 20px;"> <tr> <td><input type="checkbox"/></td> <td>0</td> <td><input type="checkbox"/></td> <td>0</td> </tr> <tr> <td><input type="checkbox"/></td> <td>0</td> <td><input checked="" type="checkbox"/></td> <td>2</td> </tr> <tr> <td><input type="checkbox"/></td> <td>0</td> <td><input checked="" type="checkbox"/></td> <td>2</td> </tr> <tr> <td><input checked="" type="checkbox"/></td> <td>1</td> <td><input checked="" type="checkbox"/></td> <td>2</td> </tr> <tr> <td></td> <td>1</td> <td></td> <td>6</td> </tr> </table>	<input type="checkbox"/>	0	<input type="checkbox"/>	0	<input type="checkbox"/>	0	<input checked="" type="checkbox"/>	2	<input type="checkbox"/>	0	<input checked="" type="checkbox"/>	2	<input checked="" type="checkbox"/>	1	<input checked="" type="checkbox"/>	2		1		6
<input type="checkbox"/>	0	<input type="checkbox"/>	0																			
<input type="checkbox"/>	0	<input checked="" type="checkbox"/>	2																			
<input type="checkbox"/>	0	<input checked="" type="checkbox"/>	2																			
<input checked="" type="checkbox"/>	1	<input checked="" type="checkbox"/>	2																			
	1		6																			

Die Schrittgröße ist 1A.

Bei Verwendung einer Fernbedienungstafel wird die Einstellung für den Landstrom über die Fernbedienungstafel eingegeben.

Generator/ Land-Unterstützung ^{MultiPlus}

Wenn der Generator oder Landanschluss zu wenig Leistung liefert, kann der Phoenix MultiPlus diese Leistung ergänzen. Auf diese Weise können Sie die Batterie schonen, da sie nicht die gesamte Leistung erbringen muss, sondern nur ergänzt. Diese Funktionsoption kann eingestellt werden.

Stellen Sie DS 3-7 ein	Stellen Sie die Generatorunterstützung an oder aus	Beispiel										
DS-8 <input type="checkbox"/> DS-7 <input checked="" type="checkbox"/> on DS-6 <input type="checkbox"/> off DS-5 <input checked="" type="checkbox"/> on DS-4 <input type="checkbox"/> off DS-3 <input type="checkbox"/> off DS-2 <input type="checkbox"/> DS-1 <input type="checkbox"/>	Bestimmen Sie, ob die Generatorunterstützung ein- oder ausgeschaltet werden muss. Die Fabrikeinstellung ist "aus". Die linke LED-Reihe steht für "aus", die rechte LED-Reihe für "an". Drücken Sie so lange auf den Druckschalter, bis die gewünschte LED-Anzeige erscheint.	Gewünscht: Generatorunterstützung ist "an". LED-Anzeige = <table border="1" style="margin-left: 20px;"> <thead> <tr> <th>Aus</th> <th>An</th> </tr> </thead> <tbody> <tr> <td><input type="checkbox"/></td> <td><input type="checkbox"/></td> </tr> <tr> <td><input type="checkbox"/></td> <td><input type="checkbox"/></td> </tr> <tr> <td><input type="checkbox"/></td> <td><input type="checkbox"/></td> </tr> <tr> <td><input type="checkbox"/></td> <td><input checked="" type="checkbox"/></td> </tr> </tbody> </table>	Aus	An	<input type="checkbox"/>	<input type="checkbox"/>	<input type="checkbox"/>	<input type="checkbox"/>	<input type="checkbox"/>	<input type="checkbox"/>	<input type="checkbox"/>	<input checked="" type="checkbox"/>
Aus	An											
<input type="checkbox"/>	<input type="checkbox"/>											
<input type="checkbox"/>	<input type="checkbox"/>											
<input type="checkbox"/>	<input type="checkbox"/>											
<input type="checkbox"/>	<input checked="" type="checkbox"/>											

Dreiphaseneinstellung MultiPlus

Zum Aufbau eines Dreiphasennetzes müssen drei Phoenix MultiPlus-Geräte des gleichen Typs gemäß Appendix 0 miteinander verbunden werden. Die Batterien müssen nach Anweisung in Appendix E oder F angeschlossen werden. Danach müssen pro Gerät noch einige Einstellungen vorgenommen werden.

Zuerst müssen Sie alle Geräte auf den Dreiphasenbetrieb einstellen.

Stellen Sie DS 3-7 ein	Schalten Sie den Dreiphasenbetrieb an oder aus	Beispiel										
DS-8 <input type="checkbox"/> DS-7 <input type="checkbox"/> on DS-6 <input type="checkbox"/> on DS-5 <input type="checkbox"/> off DS-4 <input type="checkbox"/> on DS-3 <input type="checkbox"/> off DS-2 <input type="checkbox"/> DS-1 <input type="checkbox"/>	Bestimmen Sie, ob der Dreiphasenbetrieb ein- oder ausgeschaltet sein muss. Die Fabrikeinstellung ist "aus". Die linke LED-Reihe steht für "aus", die rechte LED-Reihe für "an". Drücken Sie so lange auf den Druckschalter, bis die gewünschte LED-Anzeige erscheint.	Gewünscht: Dreiphasenbetrieb ist "an". LED-Anzeige = <table border="1" style="margin-left: 20px;"> <thead> <tr> <th>Aus</th> <th>An</th> </tr> </thead> <tbody> <tr><td><input type="checkbox"/></td><td><input type="checkbox"/></td></tr> <tr><td><input type="checkbox"/></td><td><input type="checkbox"/></td></tr> <tr><td><input type="checkbox"/></td><td><input type="checkbox"/></td></tr> <tr><td><input type="checkbox"/></td><td><input checked="" type="checkbox"/></td></tr> </tbody> </table>	Aus	An	<input type="checkbox"/>	<input type="checkbox"/>	<input type="checkbox"/>	<input type="checkbox"/>	<input type="checkbox"/>	<input type="checkbox"/>	<input type="checkbox"/>	<input checked="" type="checkbox"/>
Aus	An											
<input type="checkbox"/>	<input type="checkbox"/>											
<input type="checkbox"/>	<input type="checkbox"/>											
<input type="checkbox"/>	<input type="checkbox"/>											
<input type="checkbox"/>	<input checked="" type="checkbox"/>											

Nach dieser Einstellung muss eines der drei Geräte als Stammgerät (Master) eingestellt werden. Im Dreiphasenbetrieb nennen wir dies "Leader". Für die anderen Geräte sind keine weiteren Einstellungen nötig.

Stellen Sie DS 3-7 ein	Stellen Sie Leader/ Follower ein	Beispiel										
DS-8 <input type="checkbox"/> DS-7 <input type="checkbox"/> off DS-6 <input type="checkbox"/> off DS-5 <input type="checkbox"/> on DS-4 <input type="checkbox"/> on DS-3 <input type="checkbox"/> off DS-2 <input type="checkbox"/> DS-1 <input type="checkbox"/>	Bestimmen Sie, welches Gerät Leader, welches Follower ist. Die Fabrikeinstellung ist "Follower". Die linke LED-Reihe steht für Follower, die rechte LED-Reihe für Leader. Drücken Sie so lange auf den Druckschalter, bis die gewünschte LED-Anzeige erscheint.	Gewünscht: Dieses Gerät ist der Leader. LED-Anzeige = <table border="1" style="margin-left: 20px;"> <thead> <tr> <th>Follower</th> <th>Leader</th> </tr> </thead> <tbody> <tr><td><input type="checkbox"/></td><td><input type="checkbox"/></td></tr> <tr><td><input type="checkbox"/></td><td><input type="checkbox"/></td></tr> <tr><td><input type="checkbox"/></td><td><input type="checkbox"/></td></tr> <tr><td><input type="checkbox"/></td><td><input checked="" type="checkbox"/></td></tr> </tbody> </table>	Follower	Leader	<input type="checkbox"/>	<input type="checkbox"/>	<input type="checkbox"/>	<input type="checkbox"/>	<input type="checkbox"/>	<input type="checkbox"/>	<input type="checkbox"/>	<input checked="" type="checkbox"/>
Follower	Leader											
<input type="checkbox"/>	<input type="checkbox"/>											
<input type="checkbox"/>	<input type="checkbox"/>											
<input type="checkbox"/>	<input type="checkbox"/>											
<input type="checkbox"/>	<input checked="" type="checkbox"/>											

2.6 Wartung

Für den Phoenix Multi ist keine spezifische Wartung erforderlich. Es genügt völlig, wenn alle Anschlüsse einmal pro Jahr kontrolliert werden. Achten Sie darauf, dass der Phoenix Multi nicht feucht und schmutzig wird.

3. STÖRUNGSSUCHE

Anhand der unten stehenden Schritte können die meisten Störungen schnell gefunden werden.

Bevor Sie den Umformer und/ oder das Batterieladegerät testen, müssen die DC-Belastungen von den Batterien und die AC-Geräte vom Umformer losgekoppelt werden.

Wenden Sie sich an Ihren Victron Energy-Händler, wenn der Fehler nicht behoben werden kann.

Problem	Ursache	Lösung
Der Umformer funktioniert nicht, wenn er angeschaltet wird.	Die Batteriespannung ist zu hoch oder zu niedrig.	Sorgen Sie dafür, dass die Batteriespannung innerhalb der korrekten Wertgrenzen liegt.
Die LED-Anzeige "low battery" blinkt.	Die Batteriespannung ist zu niedrig	Laden Sie die Batterie auf oder kontrollieren Sie die Batterieanschlüsse.
Die LED-Anzeige "low battery" leuchtet.	Der Umformer schaltet sich aus, weil die Batteriespannung zu niedrig ist.	Laden Sie die Batterie auf oder kontrollieren Sie die Batterieanschlüsse.
Die LED-Anzeige "overload" blinkt.	Die Belastung auf dem Umformer ist höher als die Nennlast.	Koppeln Sie einen Teil der Belastung los.
Die LED-Anzeige "overload" leuchtet auf.	Der Umformer hat sich wegen zu hoher Belastung ausgeschaltet.	Koppeln Sie einen Teil der Belastung los.
Die LED-Anzeige "temperature" blinkt oder leuchtet.	Die Umgebungstemperatur oder die Spannung ist zu hoch.	Stellen Sie den Umformer in eine kühle, gut ventilerte Umgebung oder koppeln Sie einen Teil der Belastung los.
Die LED-Anzeigen "low battery" und "overload" blinken abwechselnd.	Niedrige Batteriespannung und zu hohe Belastung.	Laden Sie die Batterien auf, koppeln Sie einen Teil der Belastung los oder nehmen Sie Batterien mit einer höheren Kapazität. Montieren Sie kürzere und/ oder dickere Batteriekabel. Kontrollieren Sie den Dynamo.
Die LED-Anzeigen "low battery" und "overload" blinken abwechselnd.	Die Welligkeitsspannung auf dem DC-Anschluss ist höher als 1,25Vrms.	Kontrollieren Sie Batteriekabel und Batterieanschlüsse. Vergewissern Sie sich, dass die Batteriekapazität ausreicht, erhöhen Sie diese gegebenenfalls.

Problem	Ursache	Lösung
Die LED-Anzeigen "low battery" und "overload" leuchten.	Aufgrund zu hoher Welligkeitsspannung auf dem Eingang hat sich der Umformer ausgeschaltet.	Nehmen Sie Batterien mit einer höheren Kapazität. Montieren Sie kürzere und/ oder dickere Batteriekabel und starten Sie den Umformer neu auf (aus- und wieder einschalten).
Eine Alarm-LED leuchtet und eine zweite blinkt.	Der Umformer wurde von der leuchtenden LED-Anzeige alarmiert und hat sich folglich ausgeschaltet. Die blinkende LED-Anzeige gibt an, dass der Umformer infolge des betreffenden Alarms beinahe ausgeschaltet ist.	Kontrollieren Sie diese Tabelle, um den Alarm definieren und entsprechend eingreifen zu können.
Der Lader funktioniert nicht.	Die Netzspannung oder -frequenz liegt nicht im eingestellten Bereich.	Sorgen Sie dafür, dass die Netzspannung zwischen 185 Vac und 265 Vac liegt und dass die Frequenz den Einstellungen entspricht.
	Der Thermoschalter ist aktiviert.	Stellen Sie den 16A-Thermoschalter erneut ein.
Die Batterie wird nicht komplett geladen.	Falscher Ladestrom.	Stellen Sie den Ladestrom auf einen Wert zwischen der 0,1- und 0,2-fachen Batteriekapazität ein.
	Schlechter Batterieanschluss	Kontrollieren Sie die Batterieanschlüsse.
	Die Absorptionsspannung ist auf einen falschen Wert eingestellt.	Stellen Sie die Absorptionsspannung auf einen gültigen Wert ein.
	Die Ladeerhaltungsspannung ist auf einen falschen Wert eingestellt.	Stellen Sie die Ladeerhaltungsspannung auf einen gültigen Wert ein.
	Die Batteriekapazität ist zu hoch.	Schließen Sie eine Batterie mit einer niedrigeren Kapazität an und erhöhen Sie die Ladestromeinstellung.
	Die Ausgangssicherung ist defekt.	Erneuern Sie die usgangssicherung.

GB

NL

F

D

Appendix

Problem	Ursache	Lösung
Die Batterie wird überladen.	Die Absorptionsspannung ist auf einen falschen Wert eingestellt.	Stellen Sie die Absorptionsspannung auf einen gültigen Wert ein.
	Die Ladeerhaltungsspannung ist auf einen falschen Wert eingestellt.	Stellen Sie die Ladeerhaltungsspannung auf einen gültigen Wert ein.
	Die Batterie ist schlecht.	Wechseln Sie die Batterie aus.
	Die Batterie ist zu klein.	Reduzieren Sie den Ladestrom oder verwenden Sie eine Batterie mit einer höheren Kapazität.
	Die Umgebungstemperatur der Batterie ist zu hoch.	Schließen Sie einen Temperaturfühler an.

4. TECHNISCHE DATEN

Phoenix Multi/MultiPlus	12/2000/100	12/3000/120	24/2000/60	24/3000/70	48/3000/35
WECHSELRICHTER					
Eingangsspannung (V DC)	9,5-16,1	9,5-16,1	19,0-32,2	19,0-32,2	38,0-64,4
Ausgangsspannung (V AC) (5)	230 ± 2%				
Frequenz (Hz) (1)	50 ± 0,1%				
Ausgangsleistung bei 25°C (VA)	2000	3000	2000	3000	3000
Ausgangsleistung bei 25°C (W)	1800	2500	1800	2500	2500
Ausgangsleistung bei 40°C (W)	1400	1600	1500	2000	2000
P maximal (W)	4000	4500	4000	6000	6000
Maximaler Wirkungsgrad (%)	93	93	94	94	95
Nullast Leistung (W)	6	6	6	6	10
LADEGERÄT					
Eingangsspannung (V AC)	187-265				
Frequenz (Hz)	45 - 55				
Leistungsfaktor	1				
Ladespannung 'absorption' (Vdc)	14,4	14,4	28,8	28,8	57,6
Ladeerhaltungsspannung (Vdc)	13,8	13,8	27,6	27,6	55,2
Ladespannung „Lagerung“ (Vdc)	13,2	13,2	26,4	26,4	52,8
Ladestrom Bordnetzbatteie (A) (4)	100	120	60	70	35
Ladestrom Starterbatteie (A)	4	4	4	4	4
Batteriekapazität (Ah)	300-1000	400-1200	150-600	200-700	100-400
Temperatursensor	√	√	√	√	√

GB

NL

F

D

Appendix

Phoenix Multi/MultiPlus	12/2000/100	12/3000/120	24/2000/60	24/3000/70	48/3000/35
ALLG. DATEN					
Relais	√ (6)				
Kühlung aktiv	√				
Schutz (2)	a - h				
Umgebungstemperatur	-20 - 50°C				
Relative Luftfeuchte	max 95%				
GEHÄUSE					
Material & Farbe	Aluminium (Blau RAL 5012)				
Batterieanschlüsse	M8-Bolzen				
230 Volt-Anschluss	Schraubklemme 2,5 mm ²				
Schutzklasse	IP 21				
Gewicht (kg)	18	18	18	18	18
Abmessungen (HxBxT in mm)	362x258x218				
NORMEN					
Sicherheit	EN 60335-1, EN 60335-2-29				
Emissionsschutz	EN 50081-1, EN55014, EN 61000-3-2, EN 61000-3-3				
Störungsanfälligkeit	EN 55014-2				
Automotive-Richtlinie	95/54/EC				n. a.

1) Kann auf 60 Hz eingestellt werden

2) Schutz

a. Kurzschluss

b. Überbelast

c. Zu hohe Batteriespannung

d. Zu niedrige Batteriespannung

e. Batterie-Verpolungserkennung

f. Fremdspannung am Ausgang

g. Zu hohe Welligkeit der Eingangsspannung

h. Zu hohe Temperatur

3) Nicht in der Version MultiPlus erhältlich

4) Bei 25 °C Umgebungstemperatur

5) Non linear load, crest factor 3:1

6) Relais, einstellbar als allgemeines Alarmrelais, Unterspannungsalarm oder als Startrelais für einen Generator

5. APPENDIX

A Overview connections

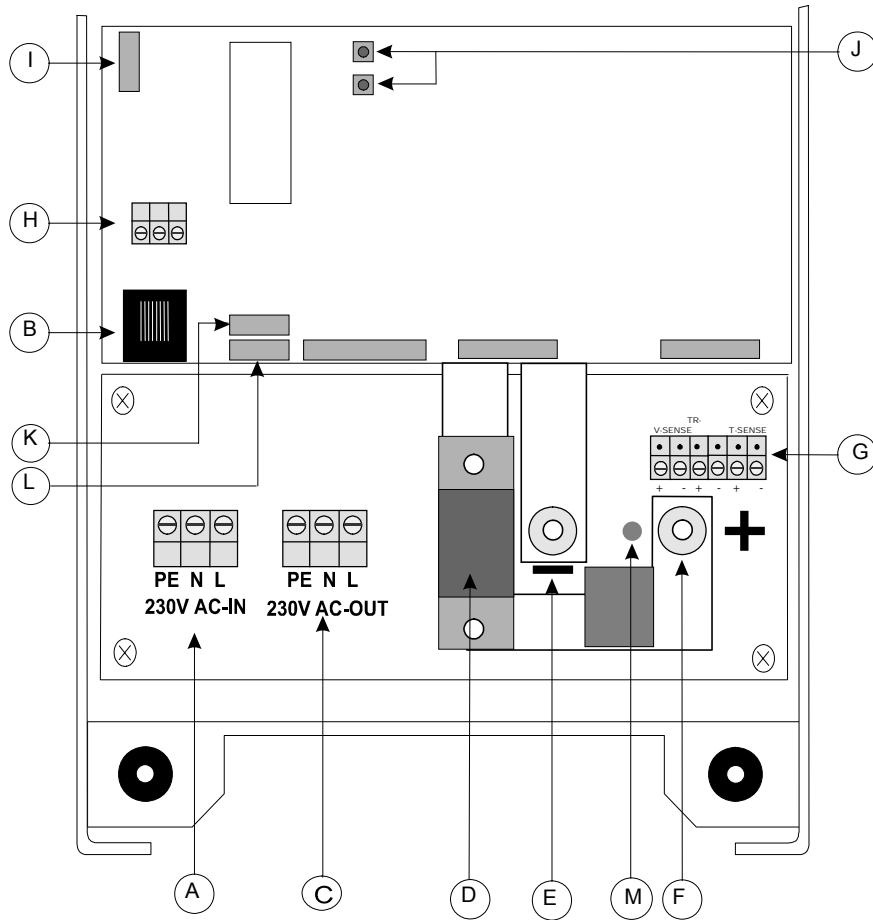

GB

NL

F

D

Appendix

A	Shore supply. AC in: (left to right) PE (ground), N (neutral), L (phase).
B	Connector for remote panel.
C	Load connection. AC out: (left to right) PE (ground), N (neutral), L (phase).
D	Megafuse F4.
E	Battery minus.
F	Battery plus.
G	Terminals for: (left to right) Voltage sense plus, Voltage sense minus, Starter battery plus, Starter battery minus, Temperature sensor plus, Temperature sensor minus.
H	Connections for remote switch: Short left and middle terminal to switch the Multi "on", Short right and middle terminal to switch the Multi to "charger only".
I	Dipswitches DS1 tm DS8 for set-up mode.
J	Pushbuttons for set-up mode.
K	Used for Parallel and 3-Phase operation, J7 IN.
L	Used for Parallel and 3-Phase operation, J8 OUT.
M	"Reversed polarity" LED.

B Dimensions

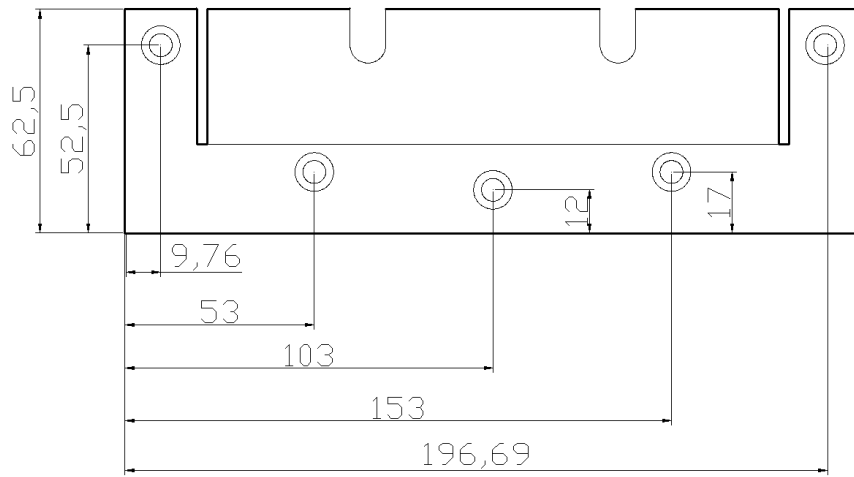

GB

NL

F

D

Appendix

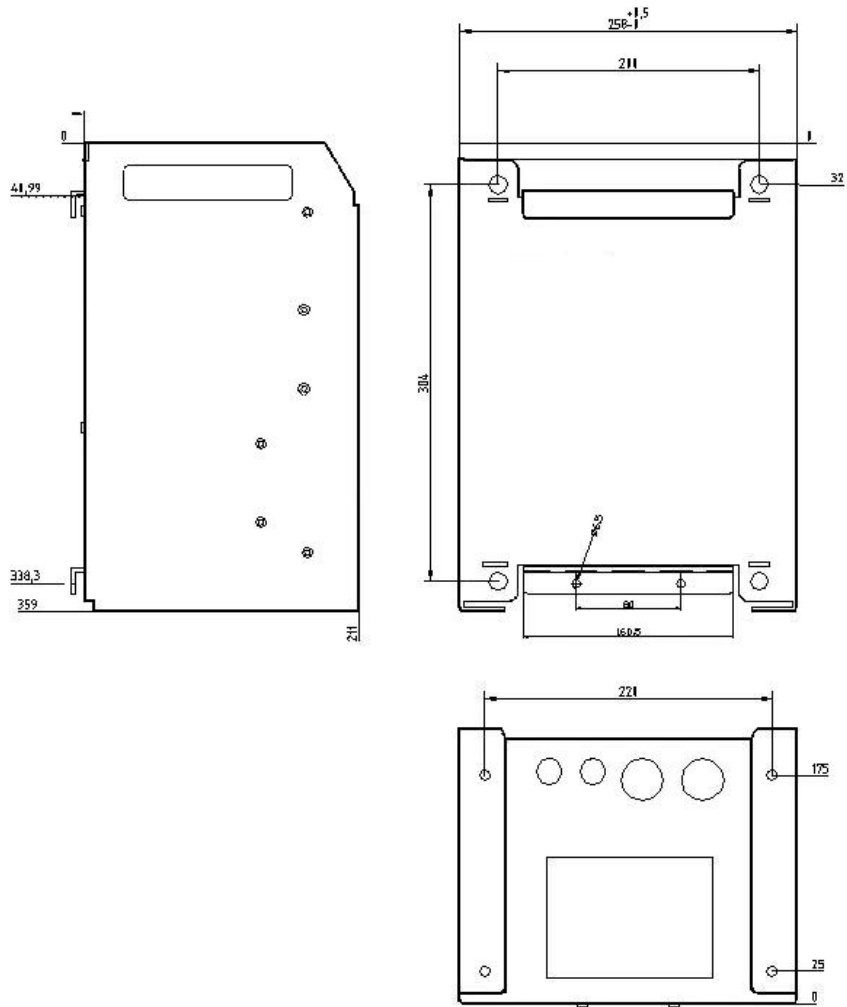

C Charge characteristics

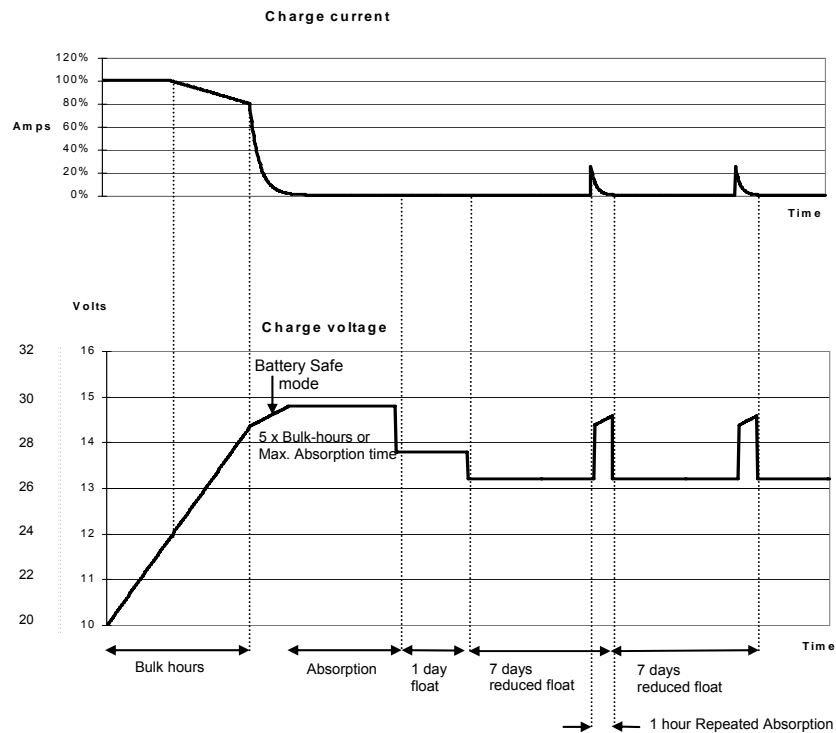

4-stage charging:

Bulk-mode: Entered when charger is started. Constant current is applied until nominal battery voltage is reached, depending on temperature and input voltage, after which constant power is applied up to the point where excessive gassing is starting (14.4V resp. 28.8V, temperature compensated).

Battery Safe Mode: The applied voltage to the battery is raised gradually until the set Absorption voltage is reached. The Battery Safe Mode is part of the calculated absorption time.

Absorption-mode: Absorption voltage is applied until $\{\text{actual-Bulk-Ah} \cdot 5 / \text{max.adjusted-Bulk-current}\}$ (in hours) is reached. Usually $\{\text{actual-Bulk-Ah} \cdot 5\} = \{\text{max.adjusted-Bulk-current} \cdot \text{Bulk-hours} \cdot 5\}$, but the actual-Bulk-current can be limited by ambient temperature, or remote control. The maximum time in Absorption mode is the Maximum Absorption time set.

Float-mode: Float voltage is applied to keep the battery fully charged and to protect it against self-discharge.

Reduced Float: After one day of Float charge a reduced Float charge is applied. This is 13,2V resp. 26,4V (for 12V and 24V charger). This will limit water loss to a minimum when the battery is stored for the winter season.

After an adjustable time (default = 7 days) the charger will enter Repeated Absorption-mode for an adjustable time (default = 4 quarters).

D Temperature compensation

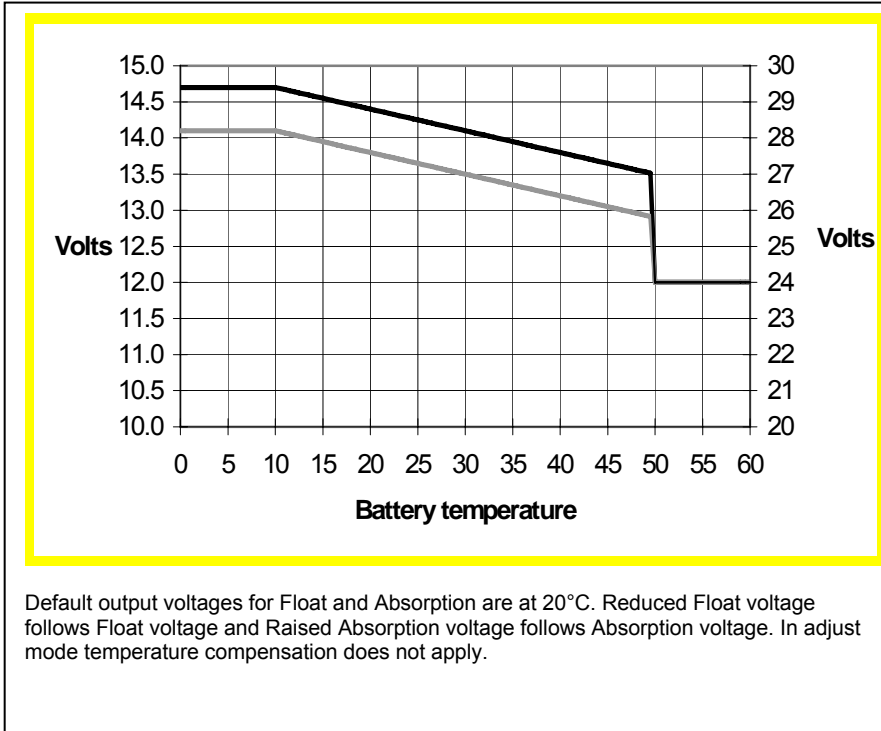

E Star connect schematic

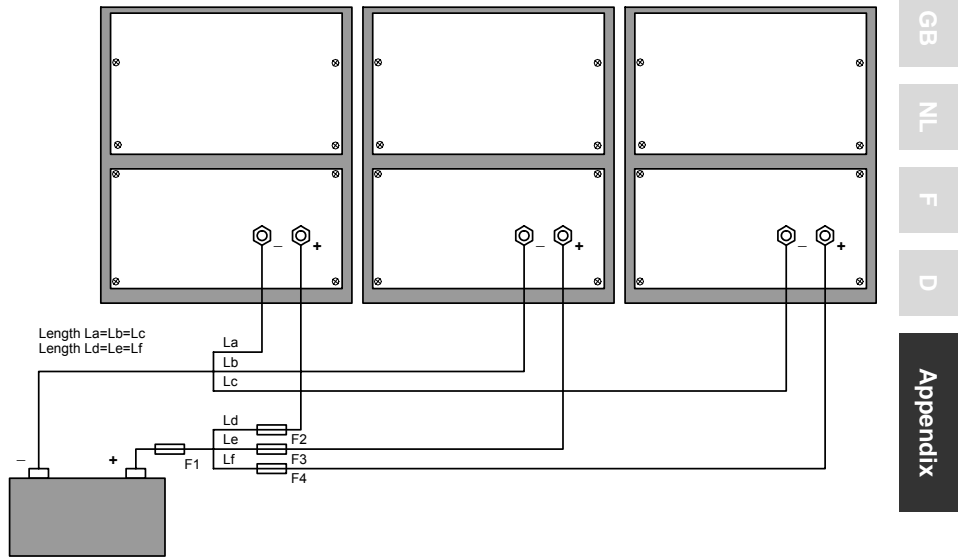

F Rail connect schematic

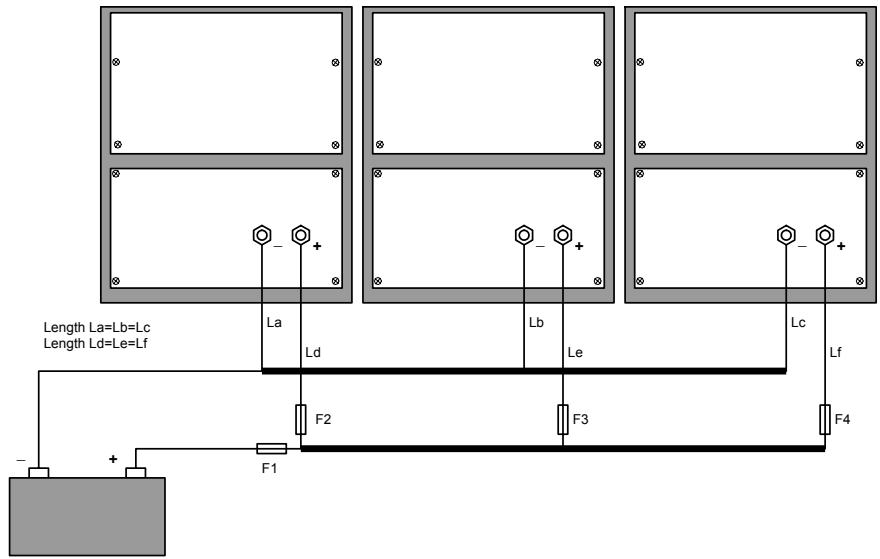

G Parallel connect schematic

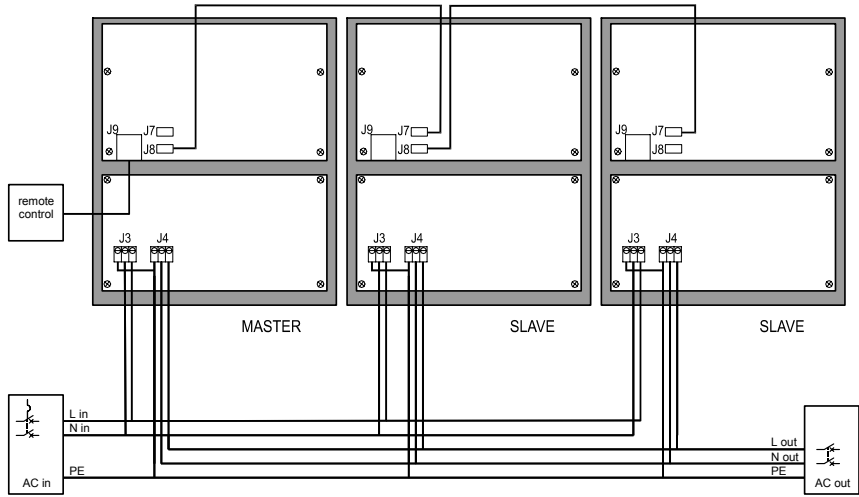

3-Phase connect schematic

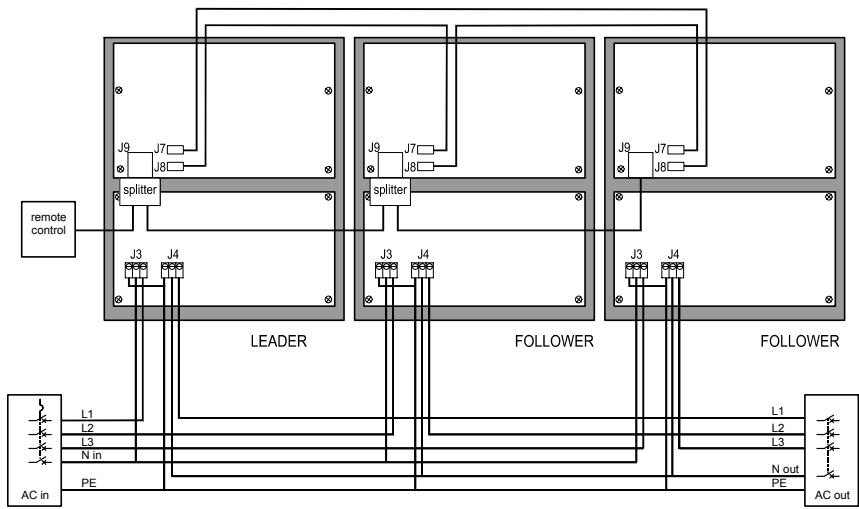

Serial number:

Distributor:

GB

NL

F

D

Appendix

Victron Energy B.V.
The Netherlands
General phone: +31 (0)36 535 97 00
Customer support desk: +31 (0)36 535 97 77
General and Service fax: +31 (0)36 531 16 66
Sales fax: +31 (0)36 535 97 40

E-mail: sales@victronenergy.com
Internet site: <http://www.victronenergy.com>

Article number: ISM010054000
Version: 05
Date: 14-11-2006